

Turmdrehkran

Tower Crane / Grue à tour / Gru a torre
Grúa torre / Guindaste de torre

200 EC-H 12 FR.tronic®

200 EC-H 10 FR.tronic®

200 EC-H 10 Litronic®

▶ 200 EC-H 12 FR.tronic®

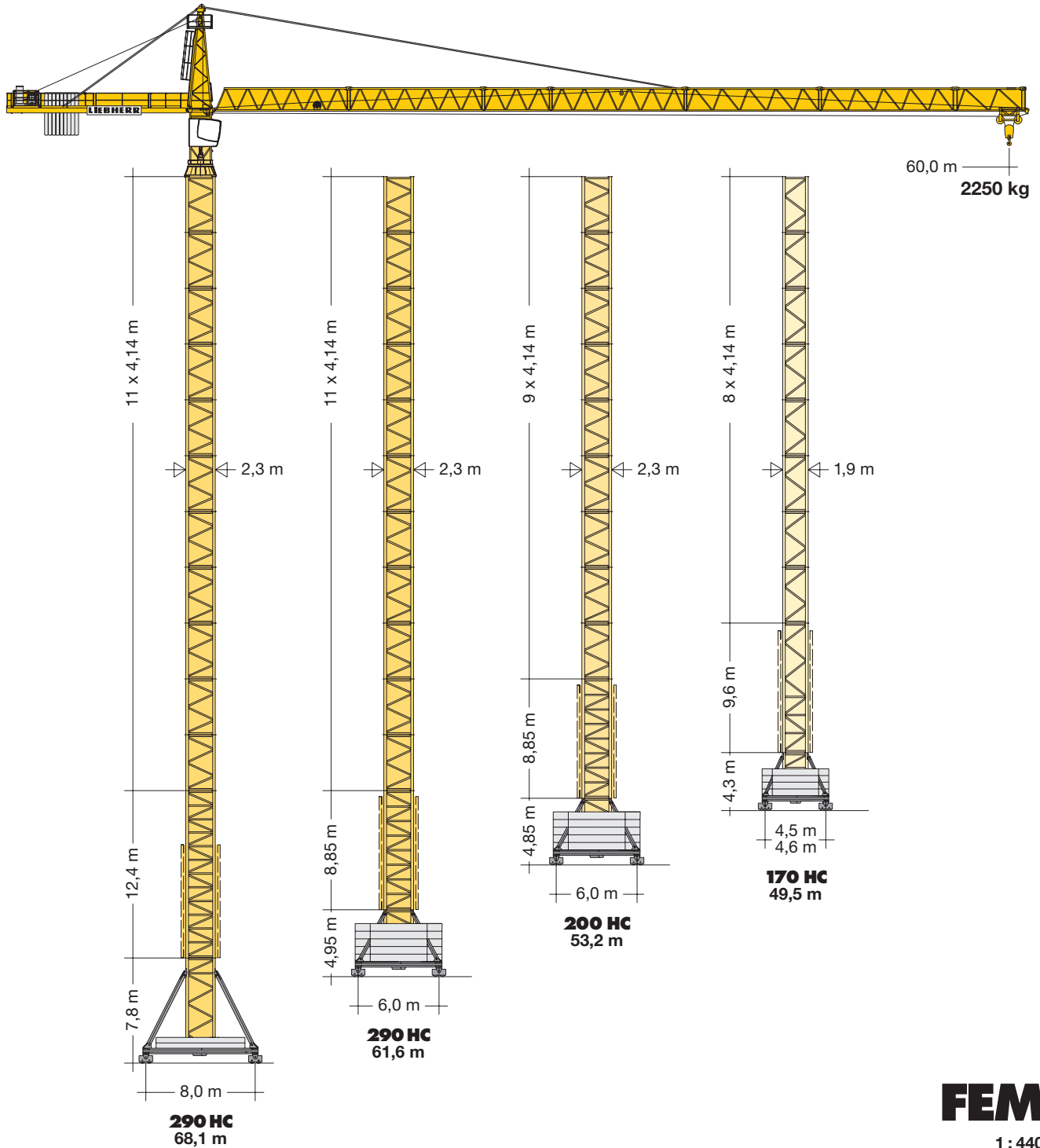

FEM

1 : 440

LIEBHERR

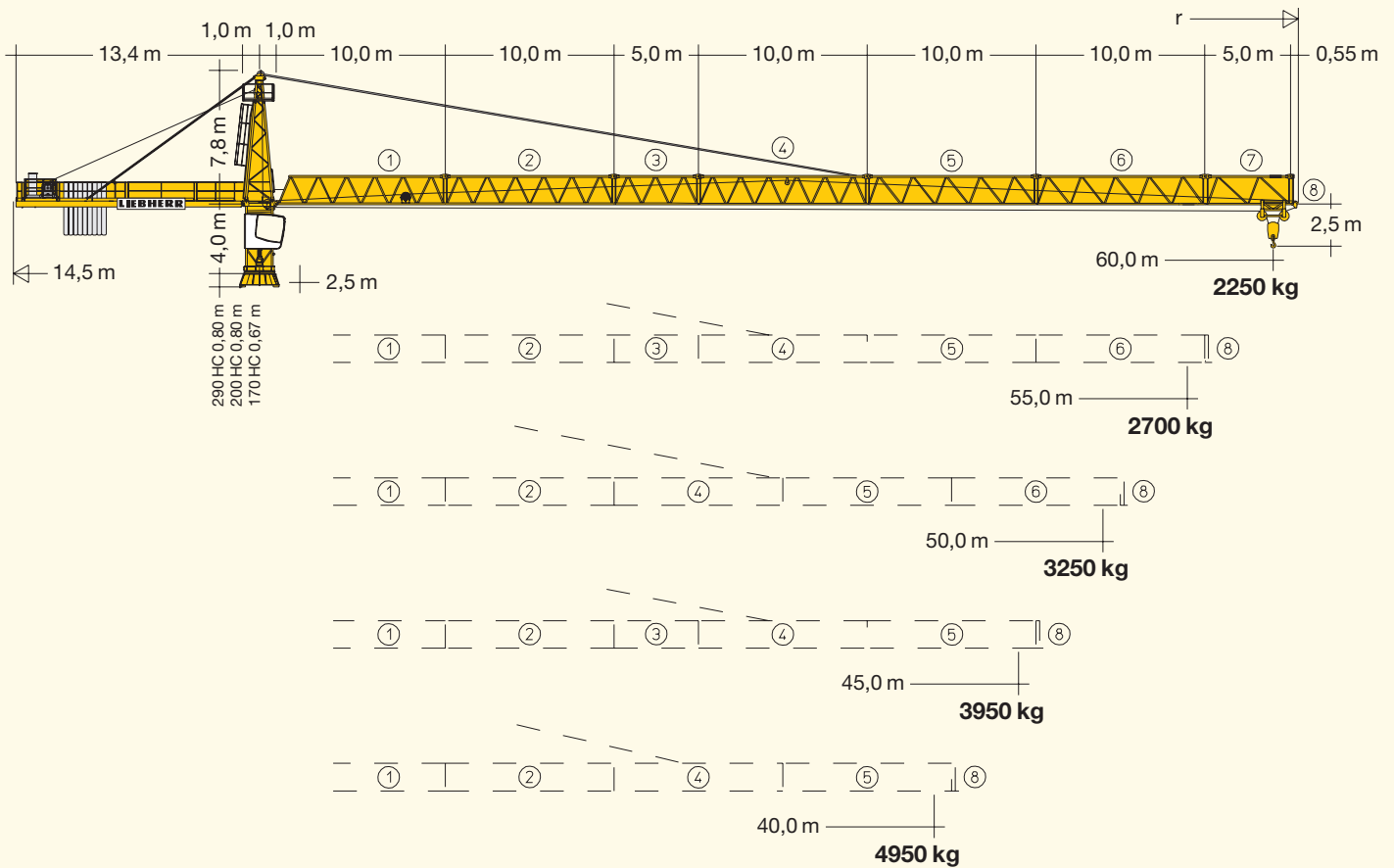

Hubhöhe

Hoisting height / Hauteur sous crochet / Altezza di sollevamento / Altura bajo gancho / Altura de montagem

	170 HC		200 HC			290 HC						
12	-	-	-	-	-	-	64,6*	-	-	-	-	-
11	-	-	-	-	-	56,9*	60,5*	61,6*	65,2*	-	-	68,1*
10	-	-	52,8*	-	-	52,8	56,3	57,5	61,1*	54,1*	57,7*	63,9
9	49,5*	-	48,6*	53,2*	50,0*	48,6	52,2	53,3	56,9	50,0	53,6	59,8
8	45,4*	49,5*	44,5	49,0	45,9	44,5	48,0	49,2	52,8	45,9	49,4	55,6
7	41,2	45,4	40,3	44,9	41,7	40,3	43,9	45,0	48,7	41,7	45,3	51,5
6	37,1	41,2	36,2	40,7	37,6	36,2	39,8	40,9	44,5	37,6	41,2	47,4
5	32,9	37,1	32,1	36,6	33,4	32,1	35,6	36,8	40,4	33,4	37,0	43,2
4	28,8	32,9	27,9	32,5	29,3	27,9	31,5	32,6	36,2	29,3	32,9	39,1
3	24,7	28,8	23,8	28,3	25,2	23,8	27,3	28,5	32,1	25,2	28,7	34,9
2	20,5	24,7	19,6	24,2	21,0	19,6	23,2	24,3	28,0	21,0	24,6	30,8
1	16,4	20,5	15,5	20,0	16,9	15,3	19,1	20,2	23,8	16,9	20,5	26,7
0	12,2	16,4	11,4	15,9	12,7	11,4	14,9	16,1	19,7	12,7	16,3	22,5
	m		m			m	a) b)	a) b)	a) b)	a) b)		

* Weitere Hubhöhen, Auslegerlängen sowie Klettern im Gebäude auf Anfrage. / Further hoist heights and jib lengths as well as climbing inside the building on request. / Autres hauteurs sous crochet et longueurs de flèche ainsi que hissage dans le bâtiment sur demande. / Ulteriori altezze gancho, lunghezze braccio così come telescopaggio all'interno dell'edificio: su richiesta. / Para alturas bajo gancho superiores, otros alcances y trepado en el interior del edificio, consultar. / Outras alturas de elevação, comprimentos de lança e subida no edifício: sob consulta.

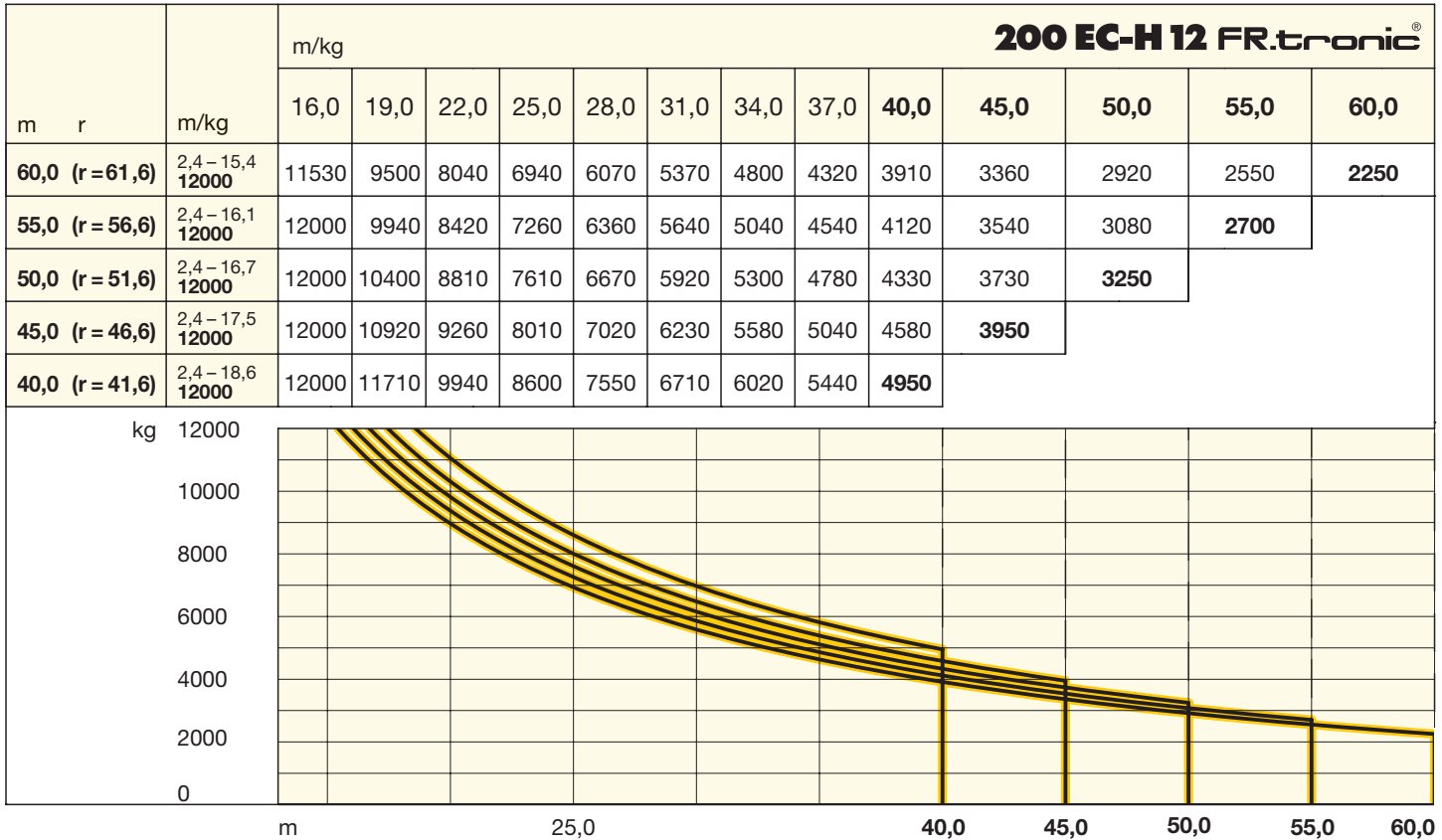

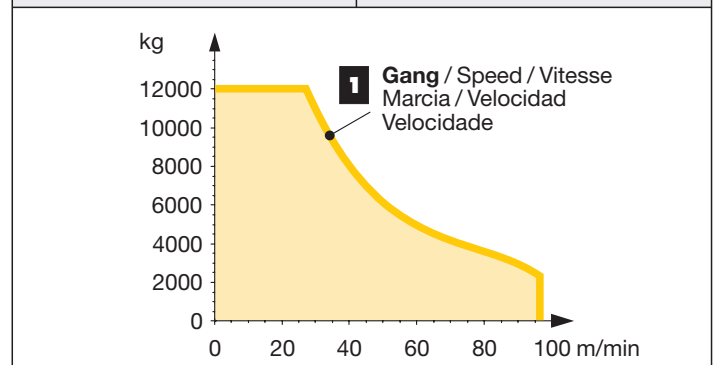
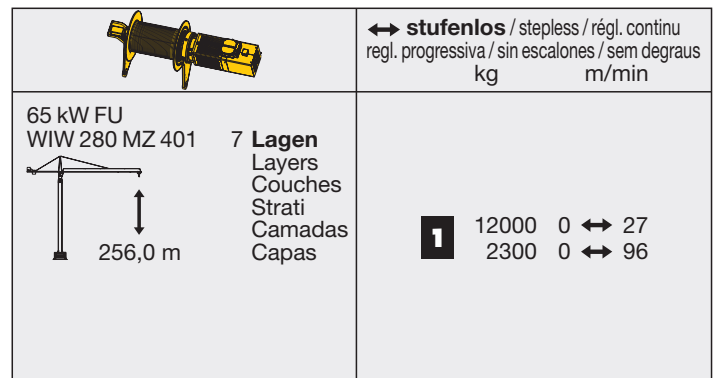
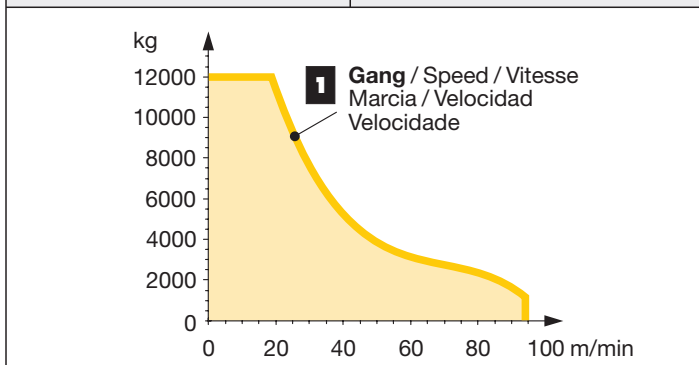
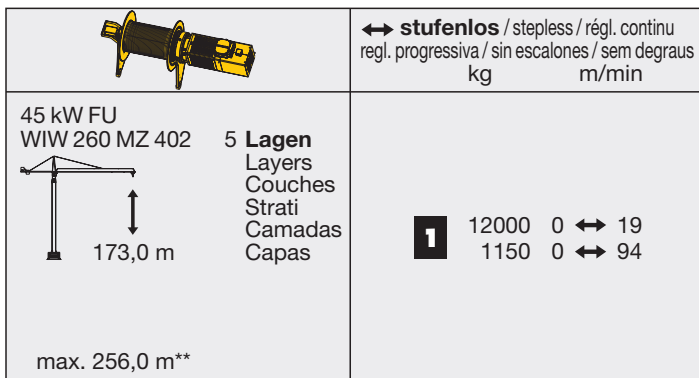

Antriebe FR.tronic®

Driving units / Mécanismes d'entraînement
Azionamenti / Mecanismos / Mecanismos

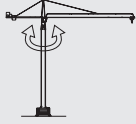
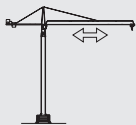
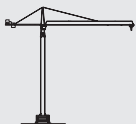

** Weitere Hublastdaten: siehe Betriebsanleitung. / Further hoist load data: see instruction manual. / Autres données de la charge de levage: voir manuel d'instruction. / Altri dati sui carichi sollevati: consultare il manuale d'istruzione. / Alturas bajo granchos superiores según manual. / Outras tabelas de carga: consultar manual de instruções.



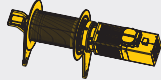









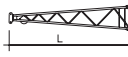











	U/min 0 ↔ 0,8 sl./min tr./min	2 x 7,5 kW FU
	0 ↔ 110,0 m/min	7,5 kW FU
	25,0 m/min	2 x 5,5 kW (170 HC, 185 HC) 2 x 7,5 kW (256 HC)

		45 kW FU 63,0	65 kW FU 86,0
--	---	------------------	------------------













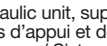





Kolli-Liste

Packing List / Liste de colisage / Lista dei colli / Lista de contenido / Lista de embalagem

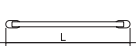
Montagewichte: siehe Betriebsanleitung. / Erection weights: see instruction manual. / Poids de montage: voir manuel de service.
Pesi di montaggio: vedasi le istruzioni sull'uso. / Peso para el montaje: según manual. / Pesos de montagem: vejäm-se es instruções p. uso.

Kranoberteil		Upper part of crane / Partie supérieure de grue / Parte superiore della gru Parte superior grúa / Parte superior do guindaste	L (m)	B (m)	H (m)	kg*		
Pos. Item Rep. Voce Pos. Ref.	Anz. Qty. Qte. Qta. Cant. Cant.	Drehbühne kpl. / Slewing platform cpl. Ensemble mât cabine cpl. / Piattaforma girevole compl. / Conjunto plataforma de giro Plataforma giratória compl.			170 HC 5,24 200 HC 5,40 290 HC 5,40	2,45 2,80 2,80	2,63 2,64 2,64	7900 8400 8400
1	1							
2	1	Turmspitze / Tower head section Porte-flèche / Testa porta-braccio Cabeça de apoio de lança			7,90	1,48	1,91	1900
3	1	Gegenausleger / Counter-jib Contre-flèche / Controbraccio Contrapluma / Contra-lança			13,50	2,30	0,61	3500
4	1	Hubwerkseinheit / Hoist gear unit / Treuril de levage / Gruppo meccanismo sollevamento / Mecanismo de elevación Grupo de mecanismo elevatório			2,20	2,39	1,74	3300
5	1	Ausleger-Anlenkstück / Jib heel section Pied de flèche / Settore articolato di braccio Pluma tramo primero / Base articulada de lança			10,29	1,71	1,98	① 2390
6	4	Ausleger-Zwischenstück / Intermediate jib section / Élément intermédiaire de flèche Spezzone di braccio / Tramo intermedio pluma Peça suplementar da lança			10,30	1,50	1,90	② 1570 ④ 1400 ⑤ 1100 ⑥ 710
7	2	Ausleger-Zwischenstück / Intermediate jib section / Élément intermédiaire de flèche Spezzone di braccio / Tramo intermedio pluma Peça suplementar da lança			5,30	1,50	1,90	③ 710 ⑦ 350
8	1	Ausleger-Kopfstück / Jib head section Pointe de flèche / Punta freccia Tramo punta de pluma / Cabeça de lança			0,72	1,66	2,03	⑧ 240
9	1	Laufkatze und Lasthaken / Trolley and hook / Chariot de distribution et crochet Carrello con gancio / Carrito y gancho Carro de ponte e gancho			1,87	1,69	1,57	1050
Turm		Tower / Mât / Torre Torre / Torre						
10	8-9 9-10 10-12	Turmstück / Tower section Élément de mât / Elemento di torre Tramo torre / Torre			170 HC 4,14 200 HC 4,14 290 HC 4,14	1,90 2,30 2,30	1,90 2,30 2,30	1850 2240 2300
11	1	Turmstück lang / Long tower section Élément de mât long / Elemento di torre, lungo Tramo de torre largo / Peça de torre, comprida			170 HC 12,42 200 HC 12,42 290 HC 12,42	1,90 2,30 2,30	1,90 2,30 2,30	4780 5460 5770
12	1	Grundturmstück / Base tower section Mât de base / Elemento di torre base Tramo base / Peça de base de torre			170 HC 9,60 200 HC 8,85 290 HC 8,85 (12,42)	1,90 2,30 2,30 (2,30)	1,90 2,30 2,30 (2,30)	4480 4280 4830 (7940)

Pos. Anz.
Item Qty.
Rep. Qte.
Voce Qta.
Pos. Cant.
Ref. Cant.

				L (m)	B (m)	H (m)	kg*	
Klettereinrichtung		Climbing equipment / Equipement de télescopage / Attrezzatura per allungamento della gru						
		Equipo de trepado / Acessórios p. subida no edificio						
13	1	Führungsstück kpl. / Guide section cpl. / Cage télescopique cpl. / Gabbia de sopraelevazione compl. / Torre de montaje completa / Peça de guia compl.			170 HC 9,04 200 HC 8,39 290 HC 8,39	2,31 2,68 2,68	2,28 2,58 (3,04) 2,58 (3,04)	4400 5210 5210
14	1	Hydraulikanlage, Stütz- und Klettertraverse / Hydraulic unit, supporting and climbing cross members / Système hydraulique avec traverses d'appui et de télescopage / Sistema hidráulico, traviesa di appoggio e allungamento gru / Sistema hidráulico con traviesa de apoyo y trepado / Instalação hidráulica, tавessa de apoio e subida			170 HC 2,00 200 HC 2,30 290 HC 2,30	1,10 1,25 1,25	1,00 1,00 1,00	1100 1150 1300
Unterwagen		Undercarriage / Châssis / Carro della gru						
		Carro con mástil / Carro de guindaste						
15	2	Fahrschemel mit Antrieb / Rail bogie with drive / Bogie moteur / Telaio con gruppo propulsore / Caja rodillo motriz / Quadro sem grupo de propulsão			170 HC 1,46 200 HC 1,46 290 HC 1,63 (1,46)	0,84 0,84 0,92 (0,84)	0,87 0,87 0,95 (0,87)	920 920 1690 (920)
16	2	Fahrschemel ohne Antrieb / Rail bogie without drive / Bogie fou / Telaio senza gruppo propulsore / Caja rodillo conducido / Quadro com grupo de propulsão			170 HC 1,15 200 HC 1,15 290 HC 1,37 (1,15)	0,60 0,60 0,62 (0,60)	0,87 0,87 0,95 (0,87)	880 880 1340 (880)
17	1	Tragholm lang / Long support arm / Longeron long / Longherone lungo / Brazo soporte largo / Travessa comprida			170 HC 7,15 200 HC 9,10 290 HC 9,10 (11,95)	0,80 0,82 0,80 (0,82)	0,70 0,74 0,80 (0,80)	1070 1350 1650 (2200)
18	2	Tragholm kurz / Short support arm / Longeron court / Longherone corto / Brazo soporte corto / Travessa curta			170 HC 3,45 200 HC 4,41 290 HC 4,45 (5,58)	0,60 0,62 0,77 (0,65)	0,70 0,71 0,77 (0,77)	500 615 850 (1035)
19	2 + 2	Randträger / Border support / Traverse / Supporti base / Traviesa / Apoio de bordo			170 HC 4,08 - 4,30 200 HC 5,48 - 5,46 290 HC 5,46 - 5,40 (7,52 - 7,46)	0,16 - 0,33 0,11 - 0,17 0,11 - 0,18 (0,10 - 0,17)	0,11 - 0,14 0,16 - 0,38 0,16 - 0,38 (0,10 - 0,38)	80 - 200 60 - 230 95 - 270 (183 - 460)
20	4	Stützholm / Support strut / Hauban de châssis / Correnti di appoggio / Tirante vertical / Travessa de apoio			170 HC 3,53 200 HC 4,23 290 HC 4,14 (6,55)	0,25 0,17 0,18 (0,22)	0,17 0,25 0,25 (0,25)	240 275 330 (600)
21	1	Unterwagen-Turmstück / Undercarriage tower section / Mât de châssis / Elemento di torre del carro / Tramo de carro / Peça de torre do chassis			170 HC 3,30 200 HC 3,73 290 HC 3,73 (6,70)	2,15 2,52 2,62 (2,53)	2,15 2,52 2,62 (2,53)	2000 2050 3000 (4200)
22	1	Kleinteile, Seile und Abspannungen / Small parts, ropes and holding bars / Accessoires, câbles et tirants / Accessori, funi e attrezzi di ancoraggio / Despieces, cables y tirantes / Acessórios, cabos e peças de ancoragem			170 HC 200 HC 9,00 290 HC	1,60	1,00	4000

() **Angaben in Klammern gelten für 8 m-Unterwagen.** / The data in brackets are valid for an undercarriage of 8 m. / Les données techniques indiquées entre parenthèses sont valables pour un châssis de 8 m. / Caratteristiche in (...) valgono per carro di 8 m. / Los datos entre paréntesis son válidos para carro de 8 m. / Características em (...) válidas pelo chassis de 8 m.

* **Einzelgewichte.** / Single weights. / Poids individuels. / Pesì di componenti. / Pesos unitarios. / Pesos de peças componentes.

Konstruktionsänderungen vorbehalten!
Subject to alterations! / Sous réserves de modifications!
Si fa riserva di modifiche! / ¡Sujeto a modificaciones!
Salvo modificação da construção!

Sämtliche Angaben erfolgen ohne Gewähr. / This information is supplied without liability.
Ces renseignements sont sans garantie. / Le indicazioni contenute si intendono salvo errori ed omissioni.
Declinamos toda responsabilidad derivada de la información proporcionada. / Declinamos qualquer
responsabilidade quanto à informação fornecida.

121 P – 2865 FEM (Section 1) Krangruppe A3 • 04.07 / 6

Printed in Germany.