

Technical data Hydraulic lift crane

LR 1300
Litronic®

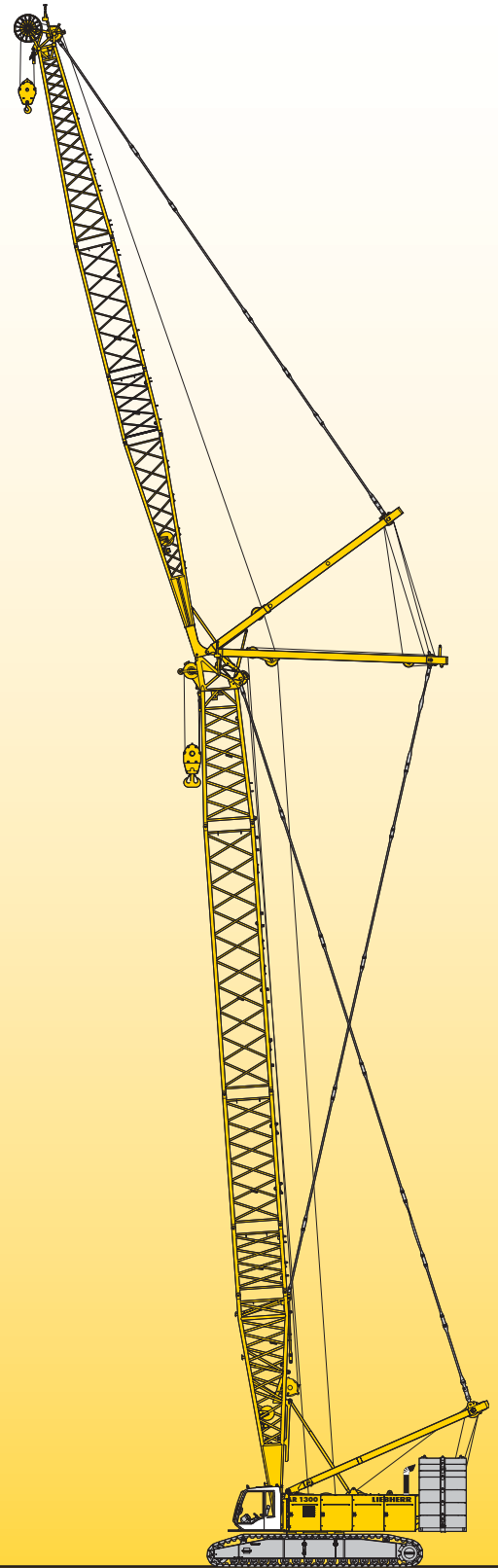

LIEBHERR

Dimensions

Basic machine with undercarriage

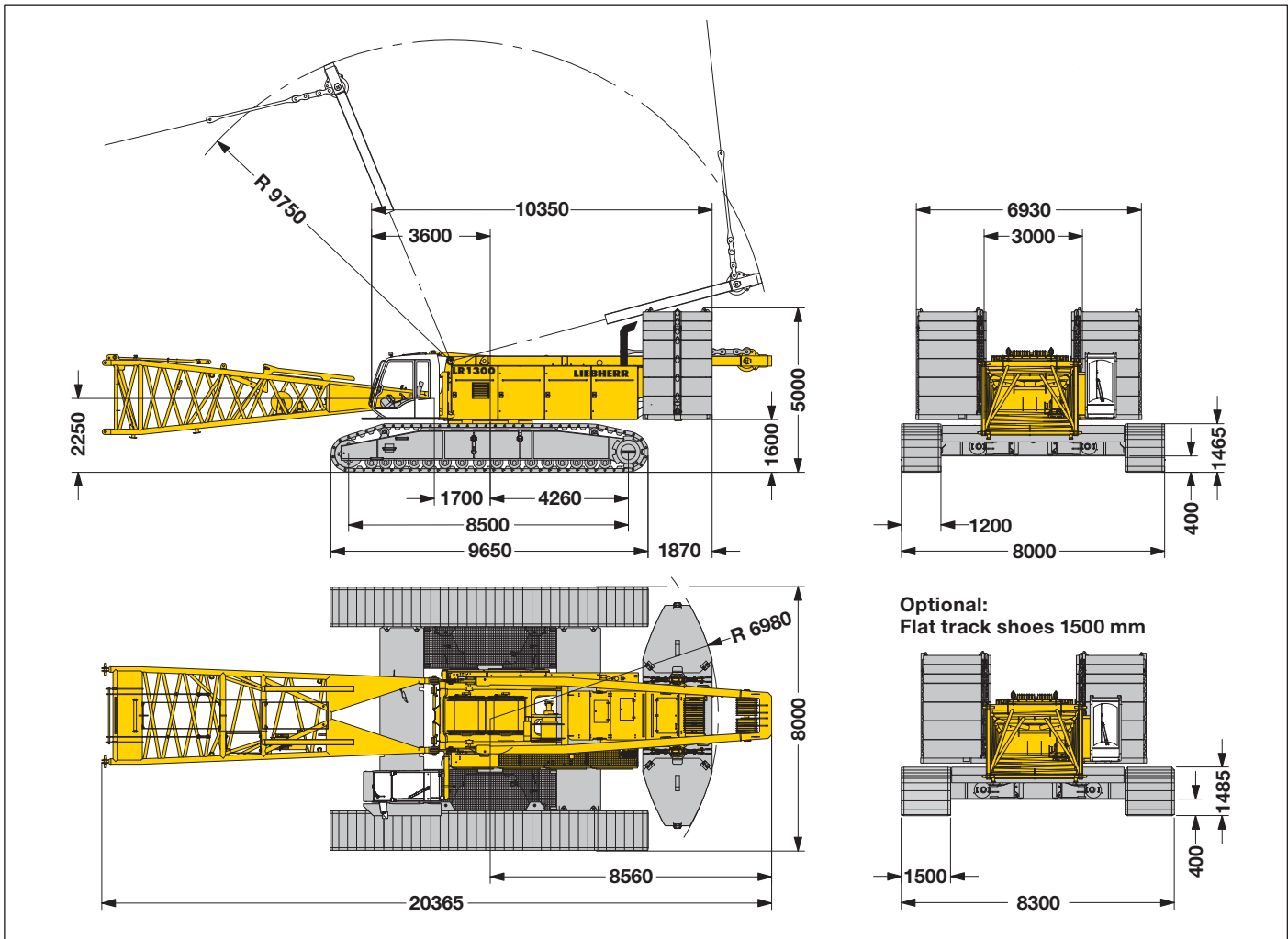

Operating weight

The operating weight includes the basic machine with crawlers, 2 main winches 150 kN and 20 m main boom, consisting of A-frame, boom foot (10 m), boom head (7 m), boom extension (3 m), 124 t basic counterweight, 57 t carbody counterweight and 300 t hook block.

Total weight _____ approx. 290 t

Ground pressure

Ground bearing pressure _____ 1.45 kg/cm²

Equipment

Main boom (No. 2821.xx) max. length _____ 98 m
 High reach boom (No. 2821.xx and 2316.xx) _____ 123 m
 Luffing jib (No. 2316.xx) max. length _____ 113 m
 Max. combination _____ main boom 59 m and luffing jib 113 m
 Auxiliary jib _____ 36 t

Remarks

1. The lifting capacities stated are valid for lifting operation only (corresponding with crane classification according to F.E.M. 1.001. crane group A1).
2. Crane standing on firm, horizontal ground.
3. The weight of the lifting device (hoisting ropes, hook block, shackle etc.) must be deducted from the gross lifting capacity to obtain a net lifting value.
4. Additional equipment on boom (e.g. boom walkways, auxiliary jib) must be deducted to get the net lifting capacity.
5. For max. wind speed please refer to lift chart in operator's cab or manual.
6. Working radii are measured from center of swing and under load.
7. The lifting capacities are valid for 360 degrees of swing.
8. Calculation of stability under load is based on DIN 15019 / part 2 / chart 1 and ISO 4305 Table 1 + 2, tipping angle 4°.
9. The structures are calculated according to F.E.M. 1.001 - 1998 (EN 13001-1; EN 13001-2).

Transport dimensions and weights

Basic machine and boom (No. 2821.xx)

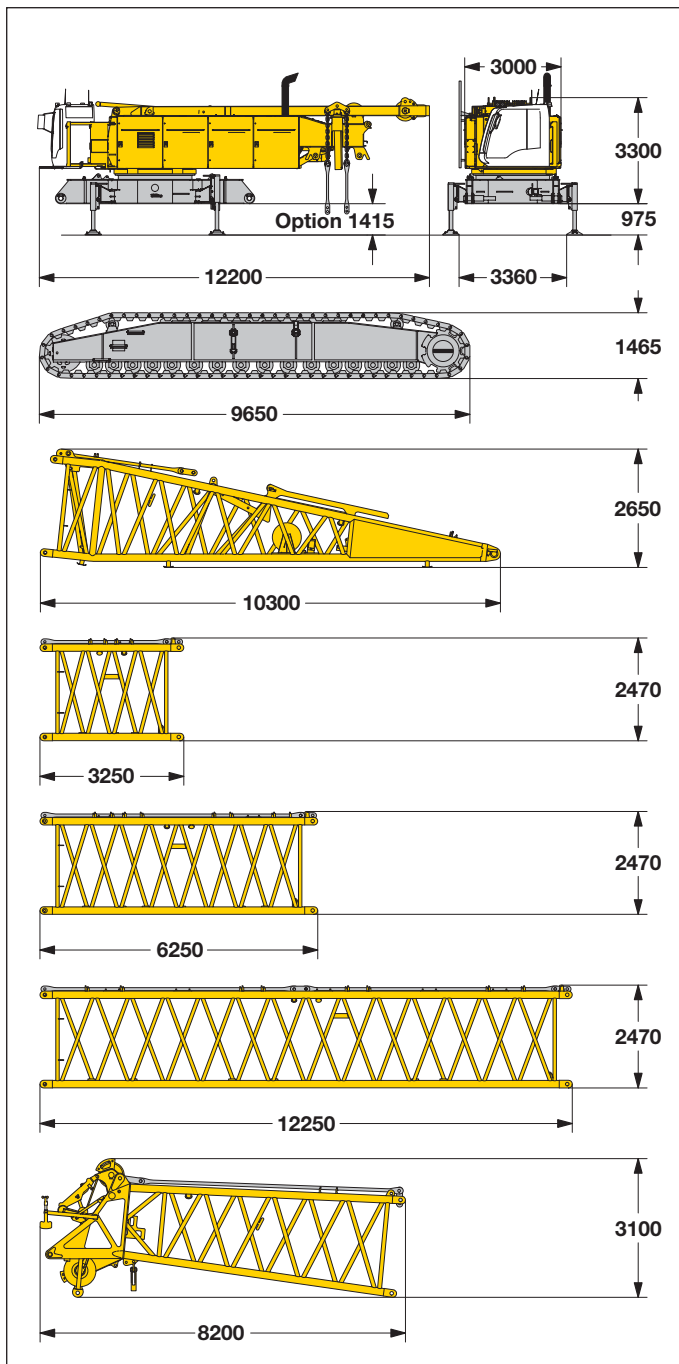

*) Including pendants

Basic machine

with A-frame, 2x 150 kN crane winches, without boom foot, hoisting ropes, basic counterweight and crawlers

Width	3000 mm
Weight	41800 kg

Crawler

	Optional	Standard
Flat track shoes	1500 mm	1200 mm
Width	1500 mm	1400 mm
Weight	26200 kg	22350 kg

Boom foot (No. 2821.30)

Width	2970 mm
Weight without winch	5700 kg
Weight incl. winch and rope	7400 kg

Boom section (No. 2821.24) 3 m

Width	2970 mm
Weight*	1200 kg

Boom section (No. 2821.24) 6 m

Width	2970 mm
Weight*	1900 kg

Boom section (No. 2821.24) 12 m

Width	2970 mm
Weight*	3350 kg

Boom head (No. 2821.24)

Width	2970 mm
Weight*	5400 kg

Boom - luffing jib transport option

No. 2821.xx/2316.xx	12/12	6/6	3/3 m
Length	12500	6250	3250 mm
Weight*	5150	2850	1810 kg

Transport dimensions and weights

Luffing jib (No. 2316.xx)

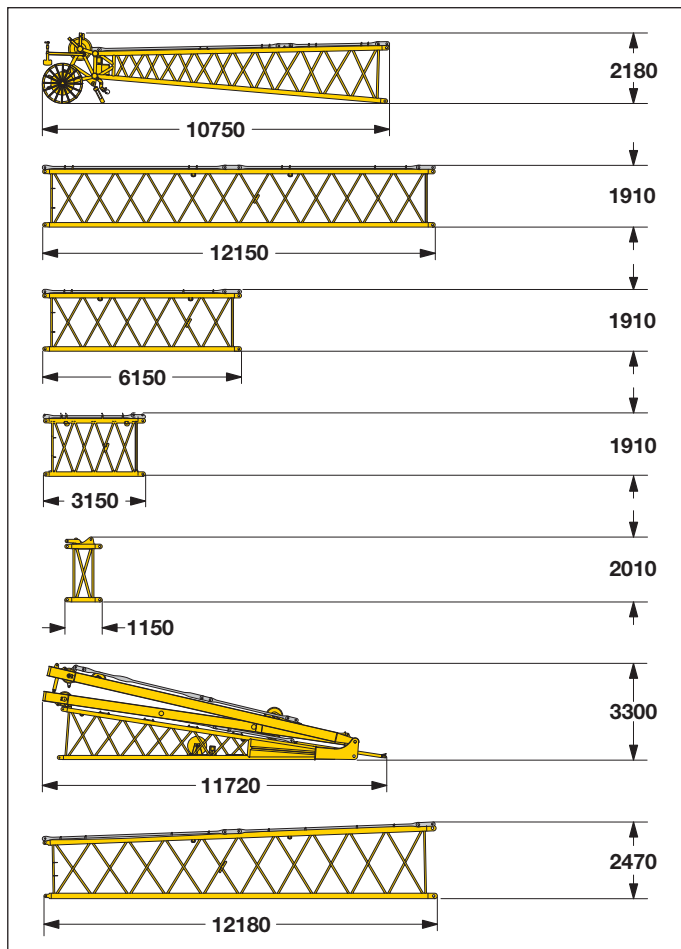

Luffing jib head (No. 2316.20)

Width	2430 mm
Weight*	2300 kg

Luffing jib section (No. 2316.20) **12 m**

Width	2430 mm
Weight*	1800 kg

Luffing jib section (No. 2316.20) **6 m**

Width	2430 mm
Weight*	950 kg

Luffing jib section (No. 2316.20) **3 m**

Width	2430 mm
Weight*	600 kg

L - boom jib section (No. 2316.20) **1 m**

Width	2430 mm
Weight*	640 kg

Luffing jib foot with A-frames (No. 2316.22)

Width	2670 mm
Weight*	8060 kg

L - boom section tapered (No. 2821/2316.24) **12 m**

Width	2970 mm
Weight*	2700 kg

Luffing jib (No. 1916.xx)

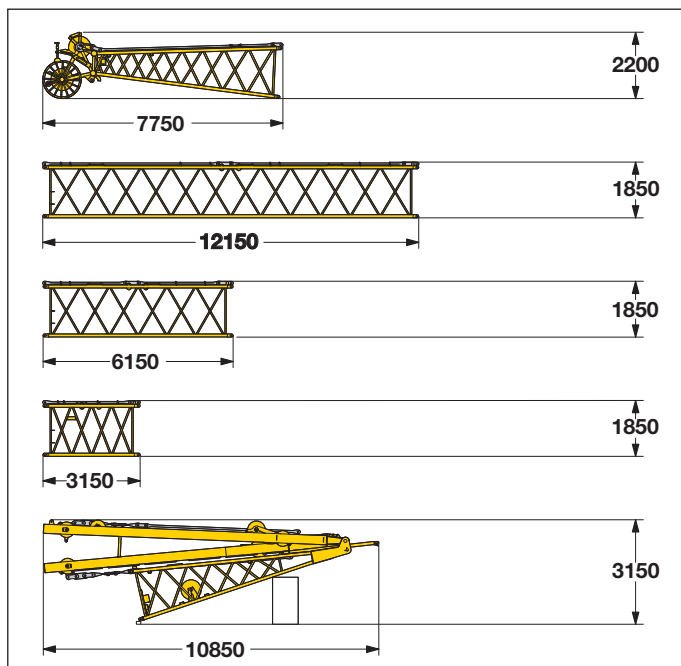

Luffing jib head (No. 1916.21)

Width	2010 mm
Weight*	1550 kg

Luffing jib section (No. 1916.18) **12 m**

Width	2010 mm
Weight*	1250 kg

Luffing jib section (No. 1916.18) **6 m**

Width	2010 mm
Weight*	690 kg

Luffing jib section (No. 1916.18) **3 m**

Width	2010 mm
Weight*	475 kg

Luffing jib foot with A-frames (No. 1916.22)

Width	2010 mm
Weight*	6300 kg

*) Including pendants

Transport dimensions and weights

Fixed jib (No. 1713.xx)

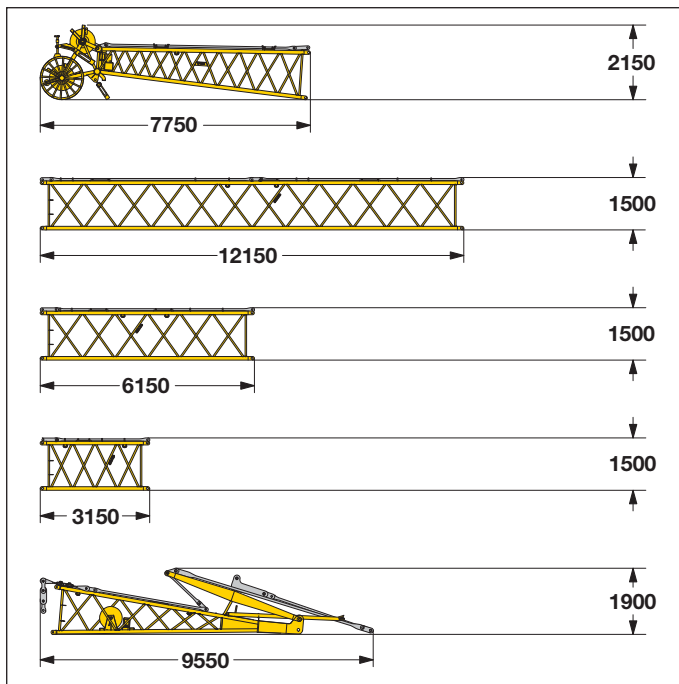

Fixed jib head (No. 1713.21)

Width	1820 mm
Weight*	1375 kg

Fixed jib section (No. 1713.18) 12 m

Width	1820 mm
Weight*	1140 kg

Fixed jib section (No. 1713.18) 6 m

Width	1820 mm
Weight*	630 kg

Fixed jib section (No. 1713.18) 3 m

Width	1820 mm
Weight*	420 kg

Fixed jib foot with A-frame (No. 1713.22)

Width	2450 mm
Weight*	2485 kg

Fixed jib (No. 1008.xx)

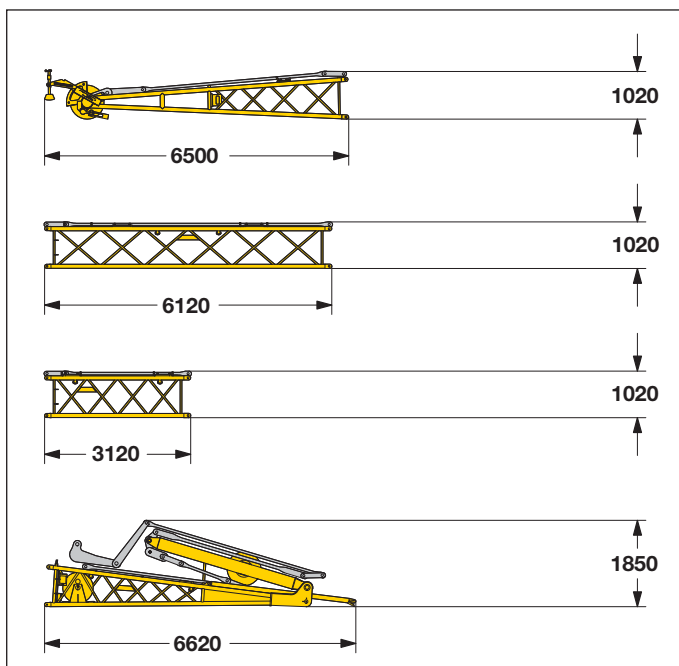

Fixed jib head (No. 1008.20)

Width	1090 mm
Weight*	920 kg

Fixed jib section (No. 1008.17) 6 m

Width	1090 mm
Weight*	630 kg

Fixed jib section (No. 1008.17) 3 m

Width	1090 mm
Weight*	300 kg

Fixed jib foot with A-frame (No. 1008.20)

Width	2200 mm
Weight*	1950 kg

Transport dimensions and weights

Counterweights

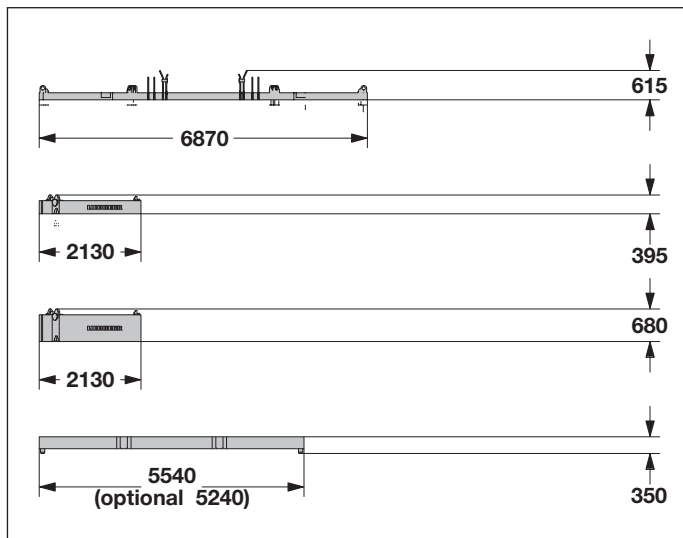

Counterweight **1x**

Width	2110 mm
Weight	14500 kg

Counterweight **6x**

Width	2110 mm
Weight	5000 kg

Counterweight **8x**

Width	2110 mm
Weight	10000 kg

Carbody counterweight **4x**

	Optional	Standard
Width	1500 mm	1200 mm
Weight	13400 kg	14250 kg

Mid fall (optional)

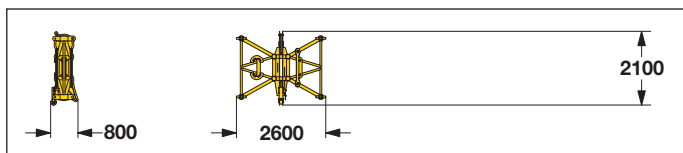

Mid fall section (No. 2316.25) **0.5 m**

Width	800 mm
Weight	690 kg

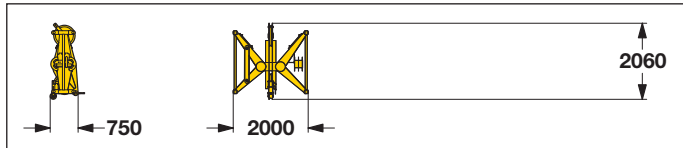

Mid fall section (No. 1916.32) **0.5 m**

Width	750 mm
Weight	685 kg

Hooks

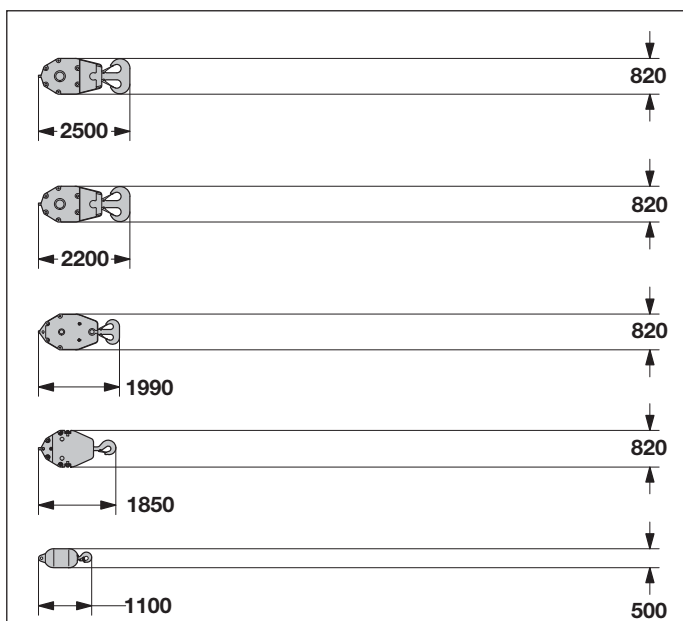

300 t hook block - 11 sheaves

Width	880	1230 mm
Weight	3200	5500 kg

150 t hook block - 5 sheaves

Width	500	660	820 mm
Weight	1600	2800	4000 kg

100 t hook block - 3 sheaves

Width	340	480	620 mm
Weight	1100	2050	3000 kg

50 t hook block - 1 sheave

Width	280	410	540 mm
Weight	800	1600	2400 kg

16 t single hook

Width	500 mm
Weight	900 kg

Technical description



Engine

Power rating according to ISO 9249, 390 kW (523 hp) at 1900 rpm
Engine type — Liebherr D 856 A7 SCR
Fuel tank — 900 l capacity with continuous level indicator and reserve warning
Engine complies with NRMM exhaust certification EPA/CARB Tier 4i or 97/68 EC Stage IIIB.



Hydraulic system

An axial displacement pump supplies the open loop hydraulic system for boom luffing, jib luffing and travel. The main hoist winches and swing are operated in a closed loop system. All functions can be operated simultaneously. To minimize peak pressure an automatic working pressure cut-off has been installed. All filters are electronically monitored.
The use of synthetic environmentally friendly (biodegradable) oils is possible.
Working pressure — max. 350 bar
Oil tank capacity — 900 l



Luffing jib winch

Line pull — max. 105 kN
Rope diameter — 20 mm
Jib luffing — 69 sec. from 15° to 78°



Boom winch

Line pull — max. 217 kN
Rope diameter — 24 mm
Boom up — 127 sec. from 15° to 86°



Swing

Consists of rollerbearing with external teeth, swing drive with fixed axial piston hydraulic motor, spring loaded and hydraulically released multi-disc holding brake, planetary gearbox and pinion.
Both swing modes are possible – speed control or free swing.
A multi-disc holding brake acts automatically at zero swing motion.
Swing speed from 0 – 1.8 rpm continuously variable.



Main winches

Line pull (1st layer) — max. 215 kN
Line pull (7th layer) — 150 kN
Rope diameter — 28 mm
Drum diameter — 730 mm
Rope speed m/min — 0 – 138
Rope capacity in 7 layers — 570 m

The winches are outstanding in their compact design and easy assembly.
Propulsion is via a planetary gearbox in an oil bath.
Load support by the hydraulic system; additional safety factor provided by a spring loaded, multi-disc holding brake.
The main winches use pressure controlled, variable flow hydraulic motors.
This system features sensors that automatically adjust oil flow to provide max. winch speed depending on load.
Option – winch with freefall system:
Clutch and braking functions on the freefall system are provided by a compact designed, low wear and maintenance free multi-disc brake.



Crawlers

Propulsion through axial piston motor, hydraulically released spring loaded multi-disc brake, crawler tracks, hydraulic chain tensioning device.
Flat track shoes — 1200 mm (optional 1500 mm)
Drive speed — 0 – 1.3 km/h



Control

The control system – developed and manufactured by Liebherr – is designed to withstand extreme environmental conditions such as temperature, vibration and electromagnetic interference and to meet all requirements that are needed in heavy duty crane operation.
Complete machine operating data are shown on a high resolution display. Standard operational information is displayed by means of graphical symbols, fault indications are displayed in plain text (more than 15 languages available).
The cranes are equipped with proportional control for all main movements, which can be carried out simultaneously.
The crane is operated with 2 multi-directional joysticks, the right for winch I and boom, the left for winch II and swing control.
Option:
Bi-directional double T-levers for simultaneous boom and luffing jib operation.
The crawlers are activated by the two foot pedals. Additionally, hand levers can be attached to the pedals.
Remote control for assembly of counterweight and boom hinge pins.



Noise emission

Noise emissions correspond with 2000/14/EC directive on noise emission by equipment used outdoors.

Boom combinations

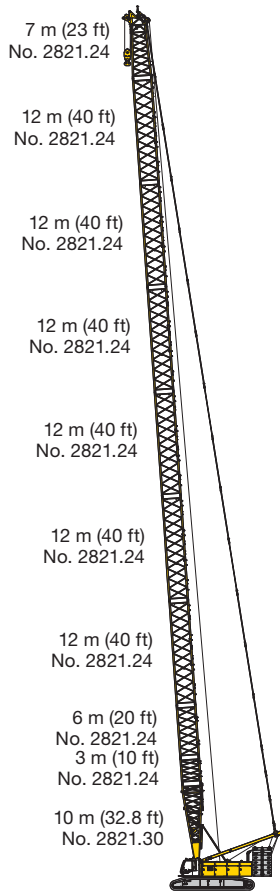

Main boom No.2821.xx — 98 m

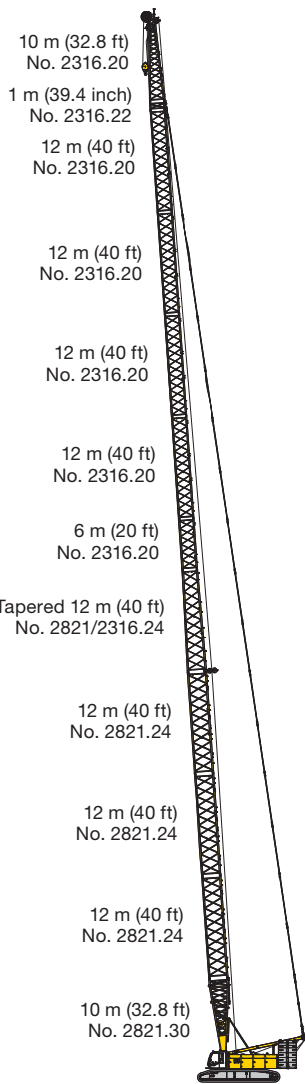

Max. combination — 123 m

Main boom No.2321.xx — 46 m

Tapered No.2821/2316.xx — 12 m

Luffing jib No.2316.xx — 65 m

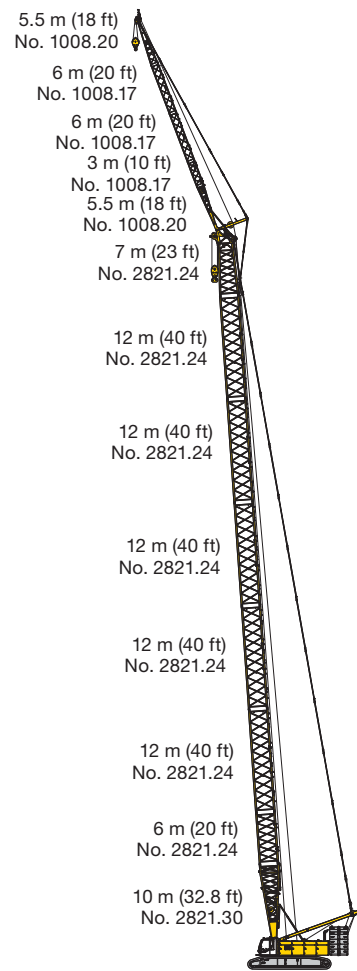

Max. combination — 109 m

Main boom No. 2821.xx — 83 m

Fixed jib No. 1008.xx — 26 m

Boom combinations

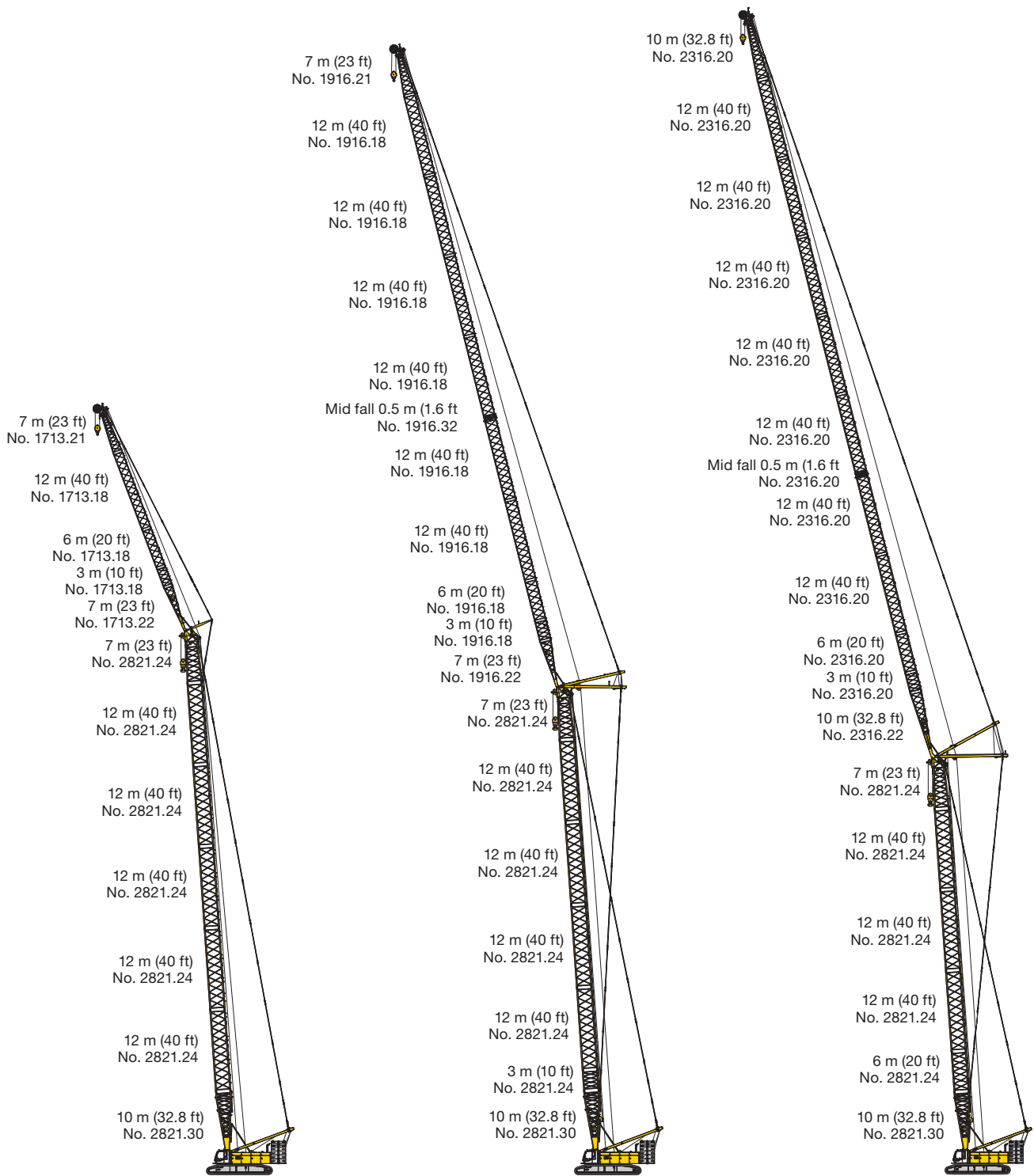

Max. combination — 112 m
 Main boom No. 2821.xx — 77 m
 Fixed jib No. 1713.xx — 35 m

Max. combination — 163 m
 Main boom No. 2821.xx — 68 m
 Luffing jib No. 1916.xx — 95 m

Max. combination — 127 m
 Main boom No. 2821.xx — 74 m
 Luffing jib No. 1916.xx — 53 m

Max. combination — 172 m
 Main boom No. 2821.xx — 59 m
 Luffing jib No. 2316.xx — 113 m

Max. combination — 115 m
 Main boom No. 2821.xx — 71 m
 Luffing jib No. 2316.xx — 44 m

Self assembly system

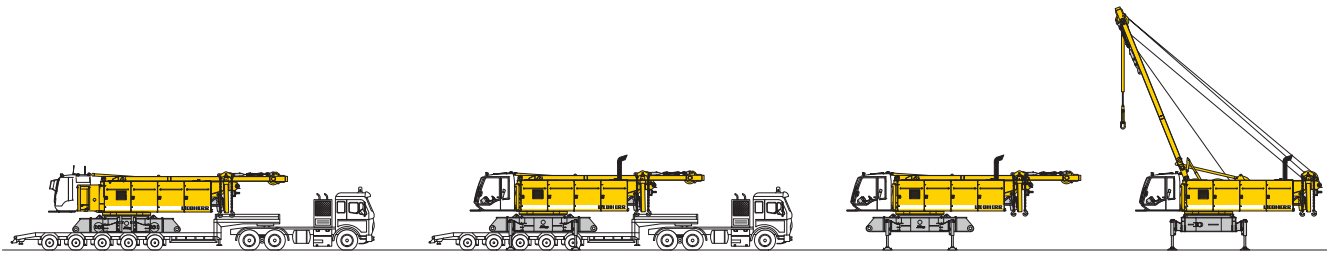

Unloading of basic machine

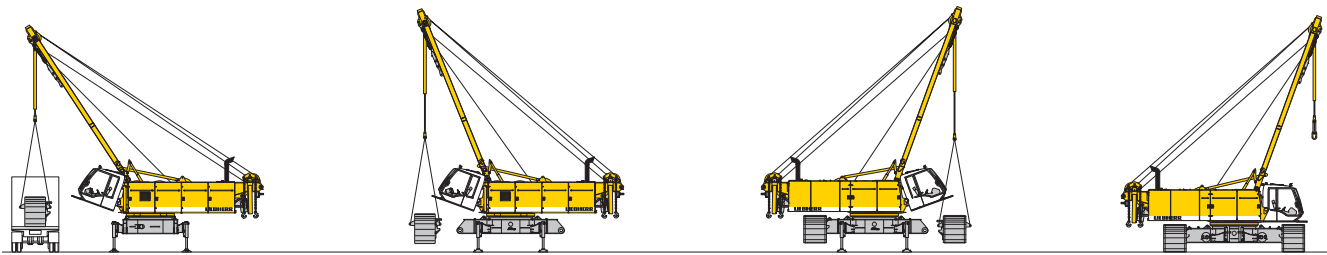

Unloading and assembly of crawlers

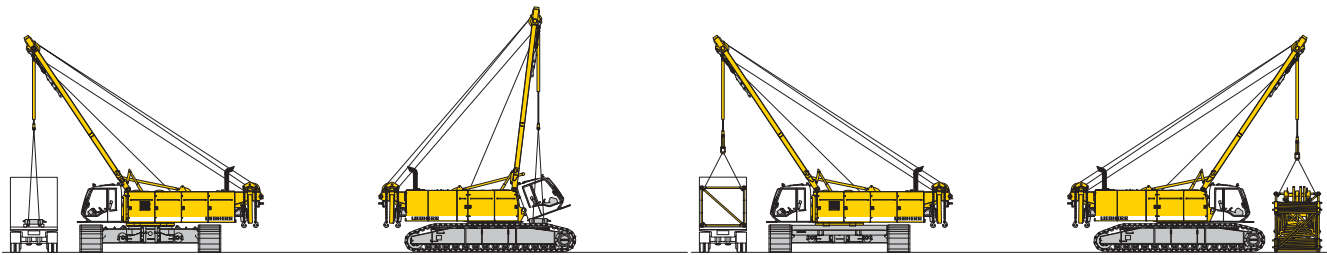

Unloading and assembly of carbody counterweight

Unloading and assembly of boom

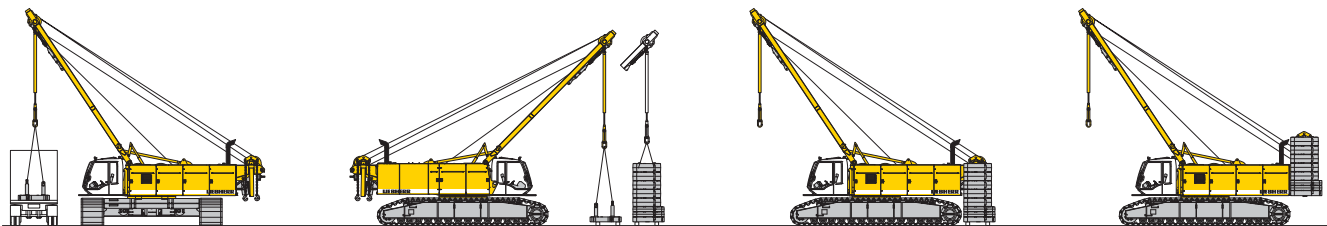

Unloading and assembly of counterweight



Unloading and assembly of boom foot

Erecting of main boom to working position

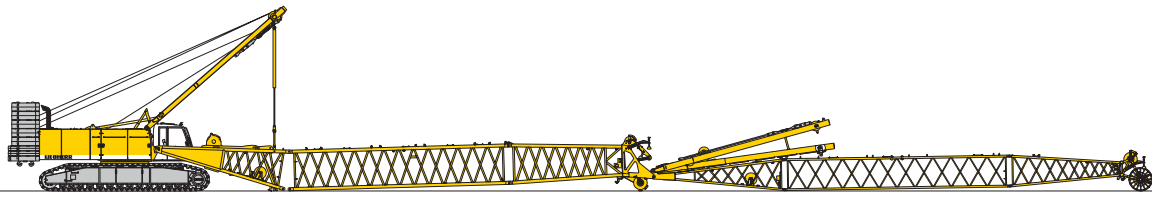

Assembly of boom

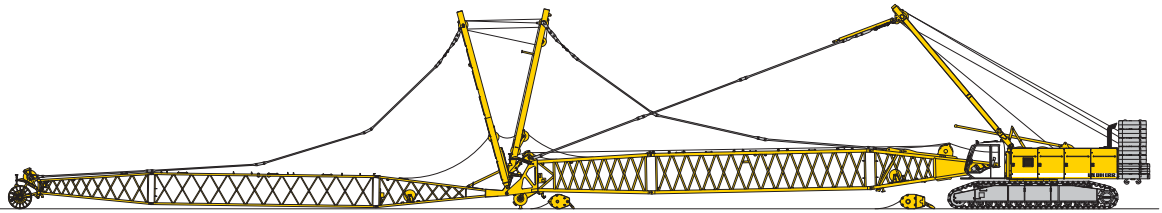

Reeving of hoist and luffing jib ropes

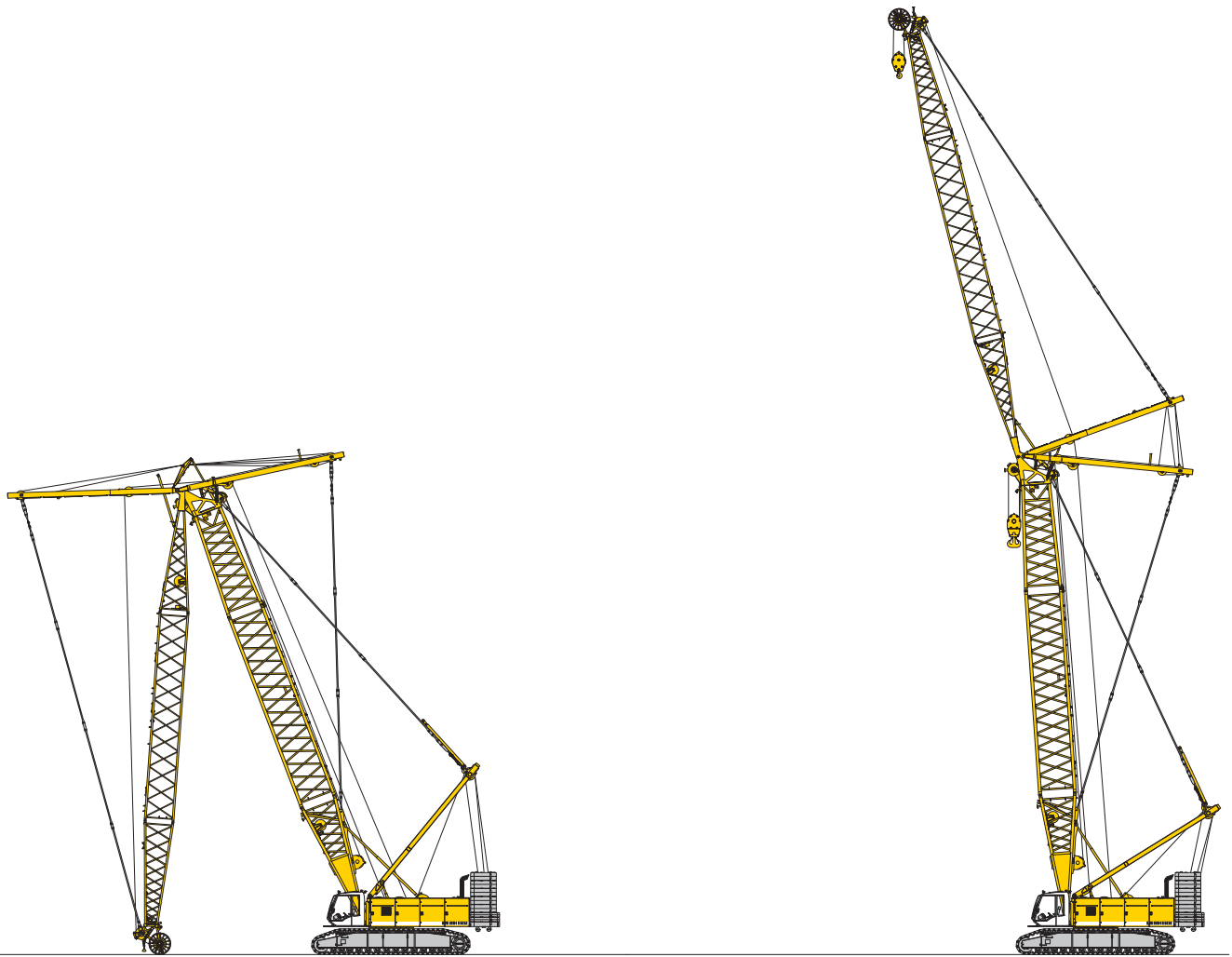

Erecting of main boom and luffing jib

Working position

Main boom (No. 2821.xx) 86° - 15°

124 t counterweight and 57 t carbody counterweight

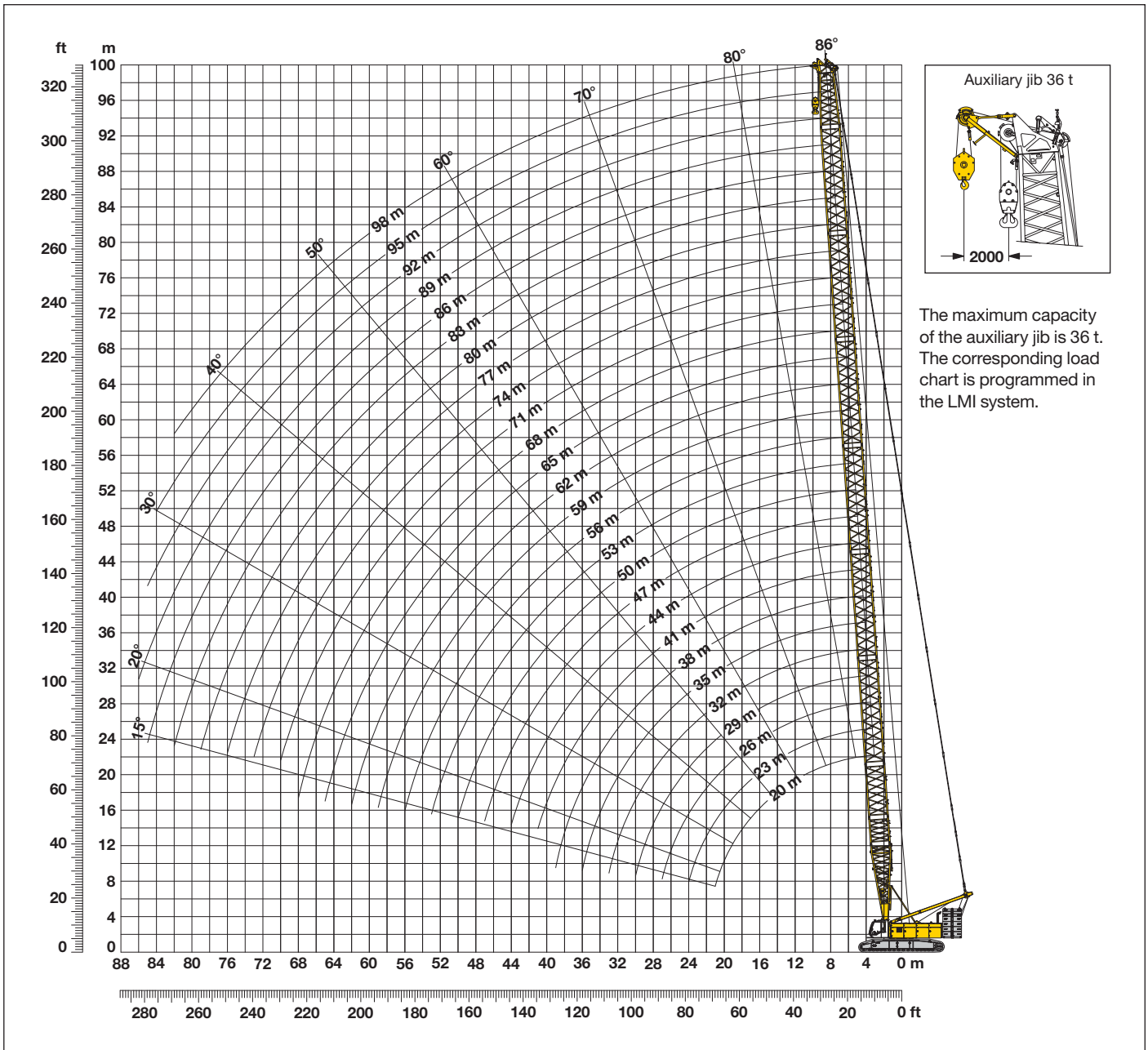

Main boom configuration (Table 1 – No. 2821.xx)

Configuration for boom lengths between 20 m and 98 m

Length	Amount of boom extensions																										
	10 m	11 m	12 m	13 m	14 m	15 m	16 m	17 m	18 m	19 m	20 m	21 m	22 m	23 m	24 m	25 m	26 m	27 m	28 m	29 m	30 m	31 m					
Boom foot	1	1	1	1	1	1	1	1	1	1	1	1	1	1	1	1	1	1	1	1	1	1					
Boom insert 3 m	1		1		1				1				1				1				1						
Boom insert 6 m		1	1				1	1				1	1				1	1			1	1					
Boom insert 12 m				1	1	1	1	1	2	2	2	2	3	3	3	3	4	4	4	4	5	5					
Boom head 7 m	1	1	1	1	1	1	1	1	1	1	1	1	1	1	1	1	1	1	1	1	1	1					
Boom length (m)	20	23	26	29	32	35	38	41	44	47	50	53	56	59	62	65	68	71	74	77	80	83	86	89	92	95	98

Lift chart for main boom (No. 2821.xx)

104 t counterweight and 57 t carbody counterweight

Radius (m)	Boom length in (m)															Radius (m)
	20	23	26	32	38	44	50	56	62	68	74	80	86	92	95	
4.3	286.2	t	t	t	t	t	t	t	t	t	t	t	t	t	t	4.3
5	286.2	300.5	296.8													5
6	258.4	259.3	257.5	245.6	237.4	212.6										6
7	225.6	225.6	222.7	216.1	207.6	198.5	189.6	169.5								7
8	196.1	196.0	195.7	191.4	185.2	179.2	169.5	162.2	150.4	127.8						8
9	173.1	173.0	172.7	172.4	166.5	161.0	153.6	145.9	138.9	125.7	109.1	97.2	83.6			9
10	154.6	154.6	154.3	154.0	151.6	144.3	137.4	131.1	125.1	118.3	104.7	96.5	83.6	73.1	67.8	10
14	107.2	107.2	106.9	106.7	103.4	99.4	95.6	92.0	88.6	85.3	82.1	79.1	74.8	67.7	63.2	14
16	89.3	89.5	89.4	89.5	88.7	85.6	82.5	79.6	76.8	74.1	71.4	68.9	66.4	62.2	59.0	16
18	75.7	76.0	75.9	76.0	75.7	74.9	72.3	69.9	67.4	65.2	62.9	60.7	58.6	56.5	54.5	18
20	65.4	65.7	65.7	65.7	65.4	65.2	64.1	62.0	59.9	57.9	55.9	54.0	52.1	50.3	49.4	20
24		51.0	51.1	51.2	50.9	50.6	50.2	49.8	48.4	46.8	45.2	43.7	42.1	40.6	39.8	24
26			45.7	45.9	45.6	45.3	44.8	44.5	44.0	42.5	41.0	39.6	38.1	36.7	36.0	26
32				34.2	34.0	33.8	33.3	32.9	32.4	31.9	31.4	30.2	29.0	27.8	27.2	32
38					26.3	26.2	25.8	25.4	24.8	24.4	23.8	23.3	22.5	21.5	21.0	38
44						20.7	20.4	20.0	19.5	19.0	18.5	18.0	17.4	16.8	16.2	44
50							16.3	16.0	15.5	15.1	14.6	14.1	13.5	13.0	12.7	50
55								13.4	13.0	12.5	12.0	11.5	10.9	10.4	10.1	55
60									10.7	10.3	9.8	9.3	8.7	8.2	7.9	60
65										8.5	8.0	7.5	6.9	6.4	6.1	65
70											6.4	5.9	5.3	4.8	4.6	70
75												4.6	4.0	3.4	3.0	75
80													2.6			80

Lift chart for main boom (No. 2821.xx)

124 t counterweight and 57 t carbody counterweight

Radius (m)	Boom length in (m)															Radius (m)
	20	23	26	32	38	44	50	56	62	68	74	80	86	92	98	
6.8								169.5								6.8
8							169.5	162.2	150.4	127.8						8
9					166.5	161.0	155.0	147.0	139.3	125.7	109.1	97.2	83.6			9
10				156.8	152.7	146.4	140.8	135.7	128.8	118.3	104.7	96.5	83.6	73.1	63.7	10
12	136.9	136.9	134.9	133.1	127.8	124.7	120.3	114.9	110.0	105.1	96.1	90.9	79.5	70.8	62.7	12
14	115.7	115.7	115.4	113.1	110.9	107.0	103.6	100.4	95.6	90.8	84.1	82.3	74.8	67.7	59.8	14
16	99.7	99.8	99.5	98.5	96.1	94.4	90.6	87.3	84.2	80.7	75.1	72.7	67.4	62.2	57.0	16
18	86.0	86.2	86.2	86.2	84.7	83.1	80.9	77.2	74.4	71.5	67.9	65.8	61.7	57.1	52.6	18
20	74.3	74.7	74.7	74.7	74.4	74.0	72.1	69.6	66.7	63.9	60.9	59.2	56.8	53.2	49.0	20
22		65.6	65.6	65.7	65.4	65.1	64.7	63.0	60.8	57.9	55.1	53.4	51.3	48.8	46.3	22
24		58.2	58.3	58.4	58.1	57.9	57.4	57.0	55.4	53.1	50.5	48.6	46.5	44.4	42.1	24
26			52.3	52.4	52.1	51.9	51.4	51.1	50.6	48.7	46.5	44.8	42.6	40.6	38.5	26
32				39.4	39.2	39.0	38.5	38.1	37.6	37.1	36.6	35.5	33.8	32.2	30.4	32
38					30.6	30.5	30.0	29.7	29.1	28.7	28.1	27.6	27.0	25.9	24.6	38
44						24.4	24.0	23.7	23.2	22.7	22.1	21.6	21.1	20.5	19.6	44
50							19.5	19.2	18.7	18.2	17.7	17.2	16.6	16.1	15.5	50
55								16.2	15.8	15.3	14.8	14.3	13.8	13.2	12.6	55
60									13.4	13.0	12.4	11.9	11.3	10.8	10.2	60
65										10.9	10.4	9.9	9.3	8.7	7.9	65
70											8.6	8.1	7.4	6.7	5.9	70
75												6.3	5.6	5.0	4.2	75
80													4.1	3.4	2.7	80
85														2.7	2.1	85

L - boom high reach (No. 2821/2316.xx) **72 m - 123 m**

Working range 78° - 15°

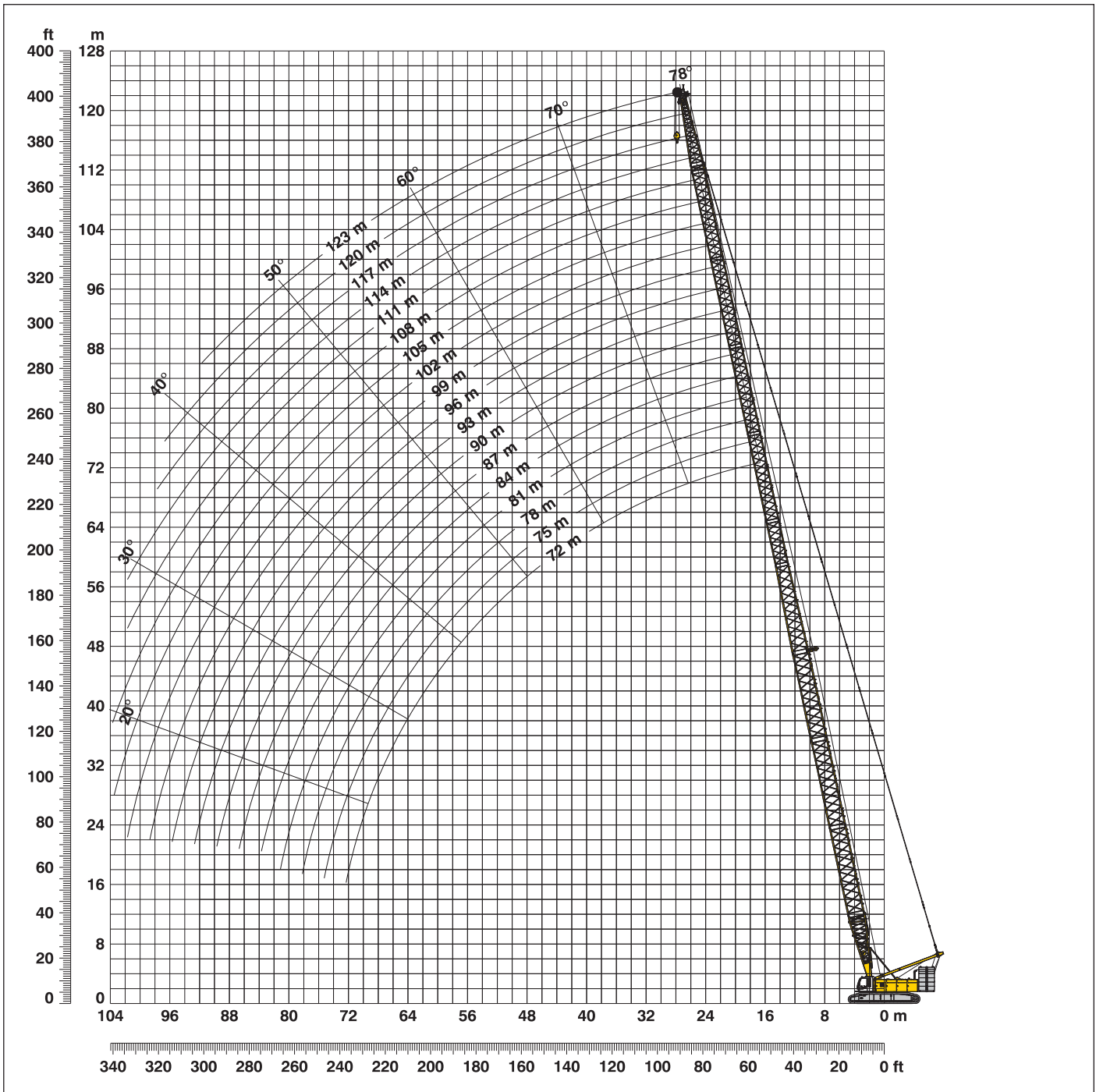

L - boom configuration with 46 m main boom (No. 2821/2316.xx)

Configuration for L - boom lengths (72 m - 123 m)

	Length	Amount of boom extensions																	
Boom foot	10 m	1	1	1	1	1	1	1	1	1	1	1	1	1	1	1	1	1	1
Boom insert	12 m	3	3	3	3	3	3	3	3	3	3	3	3	3	3	3	3	3	3
Tapered	12 m	1	1	1	1	1	1	1	1	1	1	1	1	1	1	1	1	1	1
Luffing insert	3 m	1		1		1		1		1		1		1		1		1	
Luffing insert	6 m		1	1			1		1		1		1		1		1		1
Luffing insert	12 m				1	1	1	1	2	2	2	2	3	3	3	3	4	4	4
Luffing insert	1 m	1	1	1	1	1	1	1	1	1	1	1	1	1	1	1	1	1	1
Luffing jib head	10 m	1	1	1	1	1	1	1	1	1	1	1	1	1	1	1	1	1	1
Max. L - boom length (m)		72	75	78	81	84	87	90	93	96	99	102	105	108	111	114	117	120	123

Lift chart for L – boom (No. 2821/2316.xx)

Main boom length 46 m

Radius (m)	Boom length in (m)															Radius (m)	
	72	84	87	90	93	96	99	102	105	108	111	114	117	120	123		
17.2	53.7	t	t	t	t	t	t	t	t	t	t	t	t	t	t	t	17.2
20	46.0	42.2															20
22	41.4	38.5	37.7	36.4	35.0												22
24	38.1	34.9	34.2	33.4	32.7	31.0	30.5	28.5									24
26	35.5	32.0	31.3	30.4	29.8	28.7	28.6	27.2	26.0	24.4	22.5	20.7					26
28	33.4	29.8	29.1	28.1	27.4	26.5	26.2	25.1	24.2	23.1	21.6	20.0	17.3	16.8	15.8		28
30	31.7	28.0	27.3	26.3	25.6	24.8	24.3	23.3	22.5	21.6	20.4	19.1	16.8	16.3	15.3		30
32	29.4	26.5	25.7	24.8	24.1	23.5	22.8	21.9	21.1	20.3	19.3	18.1	16.2	15.7	14.8		32
34	27.2	25.2	24.4	23.5	22.8	22.1	21.5	20.8	20.0	19.3	18.4	17.4	15.8	15.2	14.3		34
36	25.4	23.9	23.4	22.4	21.7	21.0	20.3	19.6	18.9	18.3	17.6	16.7	15.4	14.8	13.9		36
38	24.0	22.2	21.9	21.4	20.8	20.1	19.3	18.6	18.0	17.3	16.7	16.0	15.0	14.5	13.5		38
40	22.4	20.8	20.4	19.9	19.6	19.3	18.5	17.8	17.1	16.5	15.9	15.2	14.3	13.9	13.2		40
42	20.9	19.6	19.2	18.6	18.3	18.0	17.6	17.1	16.4	15.8	15.2	14.4	13.7	13.3	12.6		42
44	19.7	18.6	18.1	17.5	17.2	16.8	16.5	16.1	15.7	15.2	14.5	13.8	13.2	12.7	12.0		44
46	18.6	17.5	17.2	16.6	16.2	15.8	15.4	15.1	14.7	14.3	14.0	13.2	12.7	12.1	11.5		46
48	17.6	16.4	16.1	15.7	15.4	14.9	14.5	14.1	13.8	13.4	13.1	12.6	12.3	11.7	11.1		48
50	16.5	15.4	15.2	14.7	14.5	14.2	13.8	13.3	12.9	12.6	12.3	11.8	11.6	11.2	10.8		50
55	14.4	13.5	13.2	12.6	12.5	12.2	11.9	11.6	11.3	10.9	10.6	10.1	9.8	9.5	9.2		55
60	12.5	11.7	11.5	11.0	11.0	10.6	10.3	10.0	9.7	9.4	9.2	8.8	8.5	8.2	7.9		60
65	11.0	10.3	10.0	9.6	9.5	9.3	9.1	8.7	8.4	8.1	7.8	7.4	7.2	7.0	6.8		65
70	9.4	8.9	8.8	8.5	8.3	8.0	7.7	7.5	7.3	7.0	6.8	6.4	6.1	5.9	5.6		70
75		7.8	7.6	7.3	7.3	7.0	6.7	6.4	6.2	6.0	5.8	5.5	5.2	5.0	4.7		75
80		6.7	6.6	6.3	6.3	6.0	5.8	5.5	5.4	5.1	4.9	4.5	4.3	4.2	3.9		80
85			5.6	5.4	5.4	5.2	4.9	4.6	4.6	4.3	4.1	3.8	3.6	3.4	3.1		85
90					4.5	4.4	4.2	3.9	3.8	3.5	3.4	3.1	3.0	2.8	2.5		90
95							3.5	3.2	3.2	2.9	2.7	2.4	2.0	2.1			95
100								2.6	2.4	2.3	2.2						100

Lift chart - luffing jib (No. 2316.xx)

Main boom angle 88°

Main boom 20 m

Radius (m)	Jib length in (m)							
	20	41	53	65	77	89	101	113
12.4	t	68.7	t	t	t	t	t	t
15		53.8	48.9					
18	43.5	39.7	38.7	36.4				
20	36.9	33.6	32.4	31.7	26.4			
22	31.6	28.4	27.5	27.6	25.6			
24		25.5	24.4	23.4	22.0	18.0		
26		22.8	21.3	20.3	19.5	17.0	12.8	
28		20.7	19.2	18.2	17.1	16.0	12.6	9.1
32		17.5	16.2	14.8	14.5	12.8	12.0	8.7
36		14.9	13.9	12.6	11.4	10.5	9.3	8.0
42		12.1	11.2	9.7	8.7	7.5	6.7	5.6
50			8.5	7.3	6.1	5.1	4.1	3.5
55				6.2	5.0	3.9	3.0	2.5
65				4.4	3.4	2.6		
70					2.9	2.2		
75					2.4			

Main boom 32 m

Radius (m)	Jib length in (m)							
	20	41	53	65	77	89	101	113
12.8	t	71.8	t	t	t	t	t	t
13	86.9	71.8						
16	65.2	61.7	50.2					
18	55.1	51.9	47.5	34.8				
22	40.6	38.1	36.5	32.7	24.5			
24		33.5	32.3	29.9	23.6	17.0		
26		30.3	28.8	27.0	22.8	16.5	12.1	
28		27.5	26.1	24.9	21.6	16.2	11.9	8.5
32		23.6	22.1	20.8	19.8	15.4	11.4	8.2
36		20.5	19.1	18.0	16.6	14.7	10.8	7.8
42		17.2	15.8	14.5	13.4	11.7	9.9	7.2
55			11.0	9.8	8.6	7.3	6.3	5.0
65				7.4	6.2	5.1	3.9	3.1
70					5.4	4.1	3.1	2.2
75						4.6	3.3	2.3
85							2.2	

Main boom 41 m

Radius (m)	Jib length in (m)							
	20	41	53	65	77	89	101	113
8.8	117.0	t	t	t	t	t	t	t
14	74.3	66.2						
16	61.8	57.0	46.7					
19	48.7	45.1	42.0	32.7				
22	39.4	36.1	34.0	30.7	23.3			
24		31.9	30.3	28.3	22.4	16.1		
26		28.9	27.2	25.3	21.8	15.8	11.5	
30		24.4	22.9	21.3	19.1	15.1	11.2	8.1
34		21.2	19.6	18.2	16.7	14.0	10.7	7.7
38		18.7	17.2	15.9	14.3	12.8	10.2	7.3
44		14.5	14.3	13.0	11.7	10.1	8.8	6.8
55			10.7	9.4	8.2	6.8	5.8	4.5
65				7.2	5.9	4.7	3.6	3.0
70					5.1	3.8	2.8	2.4
75					4.4	3.1	2.1	
80						2.5		

Main boom 53 m

Radius (m)	Jib length in (m)							
	20	41	53	65	77	89	101	113
9.2	95.0	t	t	t	t	t	t	t
14	65.6	55.3						
16	55.8	49.2	41.2					
19	44.7	40.0	36.8	29.0				
22	36.7	32.9	30.3	26.9	20.5			
24	15.1	29.3	27.2	24.8	20.0	14.7		
28		24.5	22.6	20.5	17.9	14.3	10.6	
30		22.7	21.0	18.9	16.6	14.0	10.5	7.4
36		18.6	17.0	15.3	13.4	11.8	9.5	7.0
40		16.7	15.1	13.4	11.6	10.3	8.7	6.5
44		15.0	13.4	11.8	10.3	8.9	7.7	6.0
55			10.1	8.6	7.2	6.0	4.9	3.6
65				6.6	5.3	4.2	3.0	
70					4.6	3.4	2.3	
75						3.9	2.7	
80							2.2	

Main boom 59 m

Radius (m)	Jib length in (m)							
	20	41	53	65	77	89	101	113
9.2	95.0	t	t	t	t	t	t	t
14	65.6	55.3						
16	55.8	49.2	41.2					
19	44.7	40.0	36.8	29.0				
22	36.7	32.9	30.3	26.9	20.5			
24	15.1	29.3	27.2	24.8	20.0	14.7		
28		24.5	22.6	20.5	17.9	14.3	10.6	
30		22.7	21.0	18.9	16.6	14.0	10.5	7.4
36		18.6	17.0	15.3	13.4	11.8	9.5	7.0
40		16.7	15.1	13.4	11.6	10.3	8.7	6.5
44		15.0	13.4	11.8	10.3	8.9	7.7	6.0
55			10.1	8.6	7.2	6.0	4.9	3.6
65				6.6	5.3	4.2	3.0	
70					4.6	3.4	2.3	
75					3.9	2.7		
80						2.2		

Main boom 71 m

Radius (m)	Jib length in (m)							
	41	44						
14.2	39.2	t						
15	39.2	36.8						
18	34.0	33.5						
20	30.4	29.6						
24	24.4	24.1						
26	22.5	22.0						
28	20.8	20.4						
30	19.4	19.0						
32	18.3	17.8						
34	17.2	16.9						
36	16.1	15.9						
38	15.3	15.0						
40	14.5	14.2						
42	13.8	13.5						
44	13.1	12.9						
48		8.2						

Capacities in metric tons with luffing jib (No. 2316.xx) 124 t counterweight + 57 t carbody counterweight. Above lift chart is for reference only. For actual lift duty and complete chart with all available configurations please refer to lift chart in operator's cab or manual.

Lift chart – luffing jib (No. 2316.xx)

Main boom angle 83°

Main boom 20 m

Radius (m)	Jib length in (m)							
	20	41	53	65	77	89	101	113
11.5	t	t	t	t	t	t	t	t
18	110.4							
22	54.0	51.7						
24	37.4	36.0	37.1					
26	31.9	30.3	30.5					
30		27.1	27.1	28.4				
32		21.3	20.8	20.8	21.9			
36		19.6	18.9	18.5	19.0	16.4		
40		16.7	15.6	15.1	14.8	14.7	11.6	
42		14.5	13.6	12.7	11.9	12.5	10.8	8.0
44		13.5	12.5	11.5	10.9	10.8	9.9	7.9
48		12.5	11.6	10.6	9.9	9.4	9.3	7.7
55			10.2	9.2	8.2	7.5	7.1	7.3
65			8.1	7.2	6.1	5.1	4.5	4.0
70				5.0	4.0	3.0	2.1	2.2
75					3.3	2.2		
					2.6			

Main boom 32 m

Radius (m)	Jib length in (m)							
	20	41	53	65	77	89	101	113
13	t	t	t	t	t	t	t	t
20	104.7							
24	64.3	60.7						
26	45.8	49.2	44.1					
28	39.8	44.0	41.5					
30		39.5	39.1	31.1				
34		35.4	35.9	30.3	22.6			
38		29.5	30.6	28.3	22.0	15.7		
42		24.9	25.2	26.3	21.0	15.1	11.0	
44		21.6	21.5	22.2	20.0	14.5	10.6	7.6
46		20.2	19.9	20.2	19.7	14.2	10.4	7.4
55		18.7	18.5	18.6	18.4	13.9	10.2	7.2
65			13.8	13.4	13.1	11.5	9.3	6.5
80				9.8	9.2	8.6	7.4	5.6
85					5.4	4.6	4.1	3.9
90						3.8	2.9	2.7
						2.9	2.1	

Main boom 41 m

Radius (m)	Jib length in (m)							
	20	41	53	65	77	89	101	113
14	t	t	t	t	t	t	t	t
22	91.7							
24	54.3	54.4						
26	45.9	50.1	41.8					
28	41.2	43.6	40.9					
32		39.2	39.2	29.6				
36		31.9	32.6	28.6	21.4			
38		27.1	27.4	26.1	20.7	14.9		
42		25.0	25.0	24.9	20.3	14.7	10.6	
44		21.7	21.5	21.8	19.4	14.1	10.3	7.2
46		20.4	20.0	19.9	19.0	13.7	10.1	7.2
55		19.1	18.6	18.3	18.5	13.4	9.9	7.0
70			14.0	13.3	12.9	11.3	9.0	6.3
80				8.4	7.7	6.9	6.3	4.8
85					5.5	4.5	4.0	3.8
90						3.7	3.0	2.7
						2.9	2.1	

Main boom 53 m

Radius (m)	Jib length in (m)							
	20	41	53	65	77	89	101	113
15.5	t	t	t	t	t	t	t	t
22	75.8							
26	53.2	47.4						
28	40.8	41.4	35.8					
30	36.9	36.9	34.6					
34		33.6	33.3	26.4				
36		28.1	27.7	25.1	18.8			
40		26.2	25.7	23.9	18.4	13.7		
44		22.6	21.9	21.0	17.6	13.4	9.8	
48		19.9	19.1	18.3	16.4	12.9	9.5	6.7
55		17.5	16.7	15.7	15.3	12.3	9.1	6.4
60			13.7	12.6	11.6	10.9	8.4	5.9
70			11.8	10.8	9.9	9.1	7.9	5.5
80				8.1	7.1	6.4	5.4	4.2
85					5.2	4.3	3.6	2.7
95						3.6	2.7	
						2.1		

Main boom 59 m

Radius (m)	Jib length in (m)							
	20	41	53	65	77	89	101	113
16.2	t	t	t	t	t	t	t	t
24	68.5							
26	45.2	40.2						
28	40.1	37.7	31.9					
30	36.5	34.5	31.1					
34		32.1	29.7	24.3				
38		27.1	26.0	23.0	17.7			
40		23.5	22.7	20.7	17.0	13.0		
44		21.9	21.0	19.5	16.6	12.8	9.4	
46		19.3	18.5	17.2	15.2	12.3	9.1	6.3
48		18.2	17.3	16.0	14.6	12.0	8.9	6.3
60		17.2	16.2	14.9	14.1	11.6	8.7	6.1
70			11.6	10.3	9.3	8.5	7.7	5.2
80				7.8	6.8	5.9	5.0	3.9
85					5.0	4.0	3.2	2.2
90						3.3	2.4	
						2.6		

Main boom 71 m

Radius (m)	Jib length in (m)							
	41	44						
23.8	t	t						
24	31.1							
26	31.1							
28	29.9	29.0						
30	28.4	27.6						
32	26.9	26.2						
34	25.6	24.9						
36	23.9	23.7						
38	22.5	22.1						
40	21.3	20.9						
42	20.0	19.8						
44	18.7	18.6						
46	17.7	17.5						
48	16.8	16.5						
50	15.9	15.7						
	15.1	14.9						

Capacities in metric tons with luffing jib (No. 2316.xx) 124 t counterweight + 57 t carbody counterweight. Above lift chart is for reference only. For actual lift duty and complete chart with all available configurations please refer to lift chart in operator's cab or manual.

Lift chart - luffing jib (No. 2316.xx)

Main boom angle 75°

Main boom 20 m

Radius (m)	Jib length in (m)							
	20	41	53	65	77	89	101	113
18	t	t	t	t	t	t	t	t
26	76.9							
32	35.9	36.9						
36		24.9	26.3					
38		20.3	20.4	20.1				
42		18.7	18.3	18.9				
44		16.1	15.2	15.2	15.1			
46		14.9	14.2	14.0	14.7			
48		13.7	13.1	12.6	13.0	10.9		
50		12.3	12.2	11.5	11.7	10.8		
55			11.4	10.7	10.5	10.0		
60			9.7	8.9	8.2	8.0	7.4	
65				7.5	6.7	6.0	5.8	5.0
70				6.3	5.4	4.6	4.2	3.8
75				5.0	4.4	3.5	2.8	2.9
80					3.5	2.5		
					2.7			

Main boom 32 m

Radius (m)	Jib length in (m)							
	20	41	53	65	77	89	101	113
20	t	t	t	t	t	t	t	t
26	68.9							
30	45.1	42.4						
34		37.3	33.9					
40		31.1	29.5	26.8				
44		27.6	26.5	24.7	19.7			
50		23.1	22.7	21.4	19.2	13.8		
55			20.0	19.2	17.4	13.4	9.5	
60			17.2	16.9	15.8	12.7	9.3	6.3
65				15.0	14.1	11.8	8.9	6.1
70				12.8	12.4	11.1	8.6	5.8
75					11.0	9.8	8.3	5.5
80					9.3	8.6	7.6	5.2
85					7.5	7.6	6.6	4.9
90						6.3	5.8	3.3
95						4.9	4.9	
105							2.7	

Main boom 41 m

Radius (m)	Jib length in (m)						
	20	41	53	65	77	89	101
22.3	t	t	t	t	t	t	t
32	58.3						
38	41.1	36.0					
42		30.1	28.9				
48		27.2	26.1	23.5			
50		23.5	22.6	20.8	18.7		
55		22.6	21.6	19.8	18.1		
60			19.2	17.7	16.2	13.1	
65			17.1	15.9	14.3	12.3	9.1
70			14.9	14.4	13.0	11.2	8.7
75				12.9	11.8	10.2	8.3
80				11.6	10.6	9.3	7.7
85					9.3	8.2	7.2
90					8.2	7.1	6.1
95						6.2	5.1
110						5.3	4.2
							2.6
							2.0

Main boom 50 m

Radius (m)	Jib length in (m)						
	20	41	53	65	77	89	101
25.4	t	t	t	t	t	t	t
36	46.5						
40	15.1	29.7					
46		26.4	23.9				
48		22.9	21.0	18.8			
50		21.8	20.0	18.2			
55		21.0	19.1	17.2	14.8		
60		18.8	17.2	15.4	13.6	11.6	
65			15.6	14.0	12.2	10.9	8.5
70			14.2	12.6	11.0	9.8	8.4
75				11.5	9.9	8.7	7.5
80				10.4	8.9	7.9	6.6
85					8.1	7.0	5.9
90					7.0	5.9	4.9
95					6.1	5.1	4.0
100						4.2	3.2
						3.4	2.4

Main boom 59 m

Radius (m)	Jib length in (m)						
	20	41	53	65	77	89	101
28	t	t	t	t	t	t	t
36	40.7						
42	31.7	27.2					
46		23.6	21.7				
48		21.5	19.7	17.0			
50		20.5	18.8	16.9			
55		19.6	17.9	16.1			
60		17.9	16.2	14.4	12.7		
65			14.6	12.9	11.3	10.0	
70			13.4	11.7	10.1	8.9	7.5
75				10.6	9.2	7.9	6.6
80				9.7	8.2	7.1	5.7
85				8.5	7.4	6.3	5.0
90					6.4	5.3	4.2
95					5.5	4.5	3.3
100						3.6	2.6
						2.9	

Main boom 71 m

Radius (m)	Jib length in (m)					
	41	44				
38.9	t	t				
40	20.8					
42	21.5					
44	20.5	20.2				
46	19.5	19.2				
48	18.6	18.3				
50	17.9	17.5				
55	17.1	16.8				
60	15.4	15.1				
	14.1	13.8				

Capacities in metric tons with luffing jib (No. 2316.xx) 124 t counterweight + 57 t carbody counterweight. Above lift chart is for reference only. For actual lift duty and complete chart with all available configurations please refer to lift chart in operator's cab or manual.

Lift chart – luffing jib (No. 2316.xx)

Main boom angle 65°

Main boom 20 m

Radius (m)	Jib length in (m)							
	20	41	53	65	77	89	101	113
24	51.5	t	t	t	t	t	t	t
26	42.1							
30	30.2							
36		22.3						
42		15.8	15.6					
48		12.3	12.3					
50		11.3	11.0	11.2				
55			8.9	8.7				
60			7.5	6.9	6.7			
65				5.6	5.2	4.8		
70				4.6	3.9	3.5	2.8	
75					3.0	2.6	2.1	
80					2.4			

Main boom 32 m

Radius (m)	Jib length in (m)							
	20	41	53	65	77	89	101	113
30	43.1	t	t	t	t	t	t	t
36	15.1							
42		27.1						
48		22.9	21.9					
55		19.1	18.3	17.4				
65			14.5	13.7	12.7			
70				12.2	11.3	10.1		
75				10.9	9.9	8.8	7.6	
85					7.5	6.5	5.4	4.3
90					6.5	5.5	4.4	3.3
95						4.6	3.6	2.5
100						3.8	2.8	
105							2.1	

Main boom 41 m

Radius (m)	Jib length in (m)							
	20	41	53	65	77	89	101	113
34	35.0	t	t	t	t	t	t	t
38	30.5							
44		22.8						
55		17.8	16.9					
60		15.1	15.0	14.0				
65			13.4	12.4	11.3			
70			12.0	11.0	9.8			
75				9.6	8.5	7.3		
80				8.4	7.3	6.2	5.0	
90					5.4	4.3	3.2	2.0
95						3.5	2.4	
105						2.1		

Main boom 53 m

Radius (m)	Jib length in (m)							
	20	41	53	65	77	89	101	
37	28.4	t	t	t	t	t	t	
44	23.1							
50		18.0						
60		14.0	13.0					
65		12.5	11.4	10.1				
70			10.0	8.8	7.5			
75			8.7	7.6	6.4			
80				6.6	5.4	4.2		
85				5.6	4.5	3.3	2.1	
90					3.7	2.5		
95					2.9			
100					2.3			

Main boom 59 m

Radius (m)	Jib length in (m)					
	20	41	53	65	77	89
39.6	24.5	t	t	t	t	t
46	20.6					
55		14.6				
60		12.9	11.6			
65		11.3	10.1			
70			8.8	7.6		
75			7.7	6.5	5.2	
80				5.5	4.3	3.0
85				4.6	3.5	2.2
90				3.8	2.7	
95					2.0	

Main boom 71 m

Radius (m)	Jib length in (m)					
	41	44				
56.7	10.8	t				
60	10.1	9.9				
65	8.8	8.6				
70	7.6	7.5				
75		6.4				

Capacities in metric tons with luffing jib (No. 2316.xx) 124 t counterweight + 57 t carbody counterweight. Above lift chart is for reference only. For actual lift duty and complete chart with all available configurations please refer to lift chart in operator's cab or manual.

Lift chart - luffing jib (No. 2316.xx)

Main boom angle 45°

Main boom 20 m

Radius (m)	Jib length in (m)								
	20	41	53	65	77				
33.4	t	t	t	t	t				
36	30.1								
55		12.9							
65			8.5						
75				5.5					
80				4.0					
85					3.1				
90					2.2				

Main boom 32 m

Radius (m)	Jib length in (m)								
	20	41	53	65	77				
41.9	t	t	t	t	t				
44	25.3								
60		14.5							
65		12.9							
70			10.7						
75			9.4						
80				7.2					
85				6.2					
90					4.2				
100					2.7				

Main boom 41 m

Radius (m)	Jib length in (m)							
	20	41	53	65				
48.3	t	t	t	t				
50	18.9							
70		9.6						
80			6.3					
90				3.5				
95				2.8				

Main boom 53 m

Radius (m)	Jib length in (m)						
	20	41	53				
56.8	t	t	t				
60	12.2						
75		5.4					
80		4.6					
85			2.6				
0							

Main boom 59 m

Radius (m)	Jib length in (m)					
	20	41				
61	t	t				
80	9.0					
		3.0				

Capacities in metric tons with luffing jib (No. 2316.xx) 124 t counterweight + 57 t carbody counterweight. Above lift chart is for reference only. For actual lift duty and complete chart with all available configurations please refer to lift chart in operator's cab or manual.

Working range - luffing jib (No. 1916.xx) **78° - 15°**

Main boom 88° - 45°

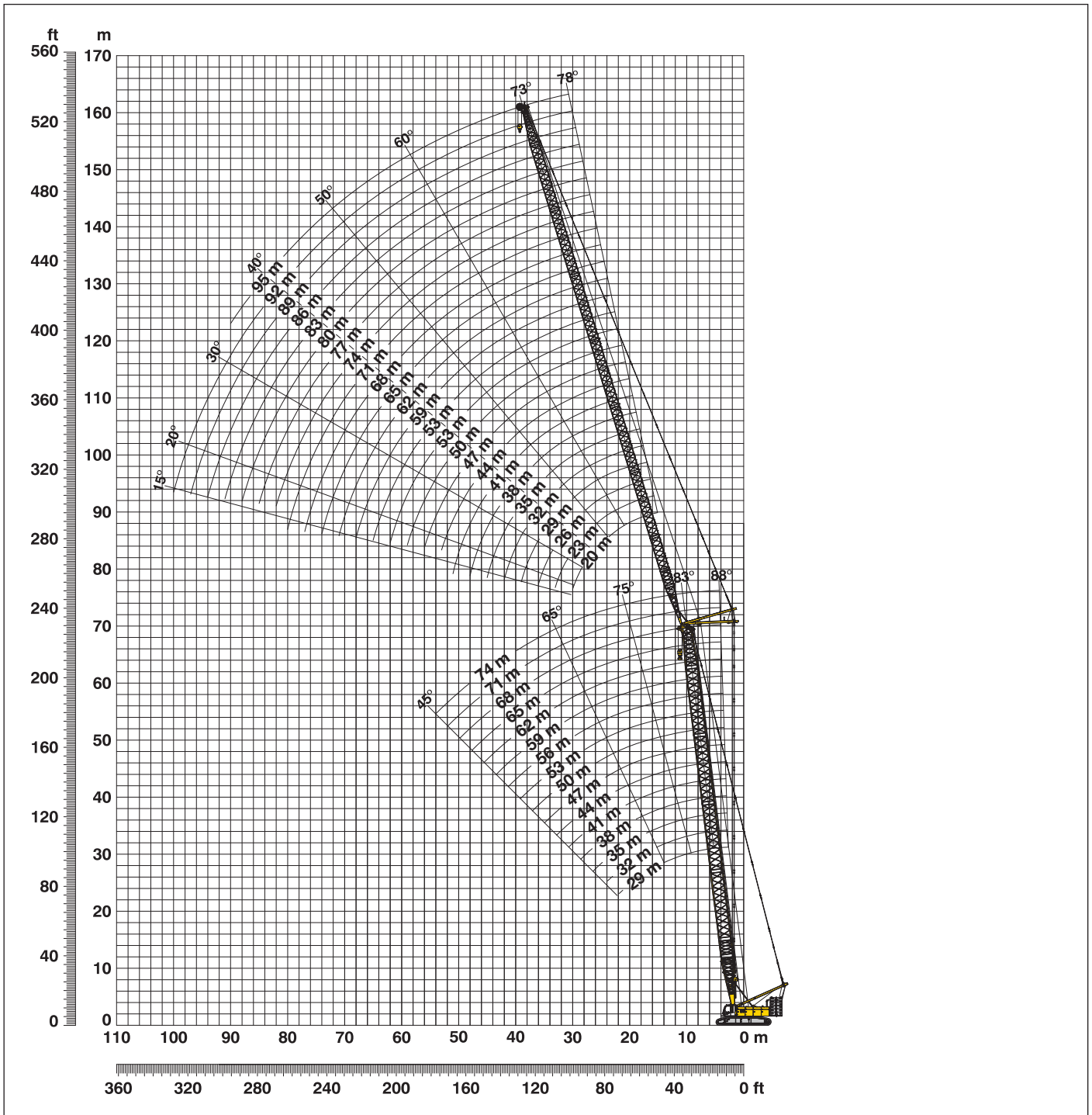

Boom configuration for main boom lengths (29 m - 74 m) – see table 1 on page 10

Jib configuration for jib lengths (20 m - 95 m)

	Length	Amount of luffing jib extensions																									
Luffing jib foot	7 m	1	1	1	1	1	1	1	1	1	1	1	1	1	1	1	1	1	1	1	1	1	1				
Luffing jib insert	3 m		1		1		1		1		1		1		1		1		1		1		1				
Luffing jib insert	6 m	1	1		1	1		1	1		1	1		1	1		1	1		1	1		1				
Luffing jib insert	12 m			1	1	1	1	2	2	2	2	3	3	3	3	4	4	4	4	5	5	5	5				
Luffing jib head	7 m	1	1	1	1	1	1	1	1	1	1	1	1	1	1	1	1	1	1	1	1	1	1				
Luffing jib length (m)		20	23	26	29	32	35	38	41	44	47	50	53	56	59	62	65	68	71	74	77	80	83	86	89	92	95

Lift chart - luffing jib (No. 1916.xx)

Main boom angle 88°

Main boom 29 m

Radius (m)	Jib length in (m)							
	20	29	35	47	59	71	83	95
13	t	t	46.5					
14			44.7	31.2				
15		50.3	42.6	30.7				
17		45.9	39.4	28.8	20.3			
18	51.5	44.2	37.6	27.7	19.9			
19	48.7	42.2	36.1	26.8	19.2	13.8		
22	38.5	37.5	32.6	24.6	17.8	13.0	9.1	
24		34.4	30.4	23.3	17.1	12.5	8.8	6.0
28		29.1	26.9	21.4	16.1	11.8	8.2	5.7
32		15.1	23.8	19.8	15.5	11.2	7.8	5.3
36			20.5	18.2	14.8	10.7	7.4	5.0
48				12.9	12.7	9.4	6.4	4.2
60					9.2	8.3	5.7	3.4
70						6.8	5.2	2.8
80							4.5	2.3
85								2.0

Main boom 41 m

Radius (m)	Jib length in (m)							
	20	29	35	47	59	71	83	95
10.6	t	t	57.8					
11	69.6	57.8						
12	65.7	55.5	45.9					
15	55.4	49.2	41.0	29.6				
17	50.6	44.8	38.1	27.8	19.4			
20	43.6	39.7	33.9	25.4	18.2	13.2		
22	39.0	36.7	31.9	24.2	17.4	12.7	8.8	
26		30.5	28.1	22.0	16.2	11.8	8.3	5.7
28		27.8	26.4	21.1	15.7	11.5	8.0	5.5
32		24.2	23.2	19.7	15.1	10.9	7.6	5.2
38			19.4	17.2	14.2	10.3	7.0	4.7
48				13.2	12.3	9.2	6.3	4.1
60					9.5	8.2	5.6	3.4
70						6.9	5.1	2.8
80							4.5	2.3
85								2.1

Main boom 53 m

Radius (m)	Jib length in (m)							
	23	29	35	47	59	71	83	95
9.8	63.6	t	t	t	t	t	t	t
11	60.7	52.4						
13	54.1	50.0	42.0					
15	48.4	45.8	39.3	27.7				
18	42.1	40.4	35.5	25.9	18.3			
20	38.8	37.1	32.9	24.4	17.5	12.6		
24	32.2	31.3	28.8	22.3	16.1	11.7	8.3	
26	29.5	28.5	27.0	21.4	15.6	11.4	8.0	5.5
32		23.0	22.0	18.9	14.6	10.6	7.4	5.0
38			18.6	16.6	13.7	10.0	6.9	4.6
50				12.3	11.2	8.9	6.1	3.9
60					9.1	7.8	5.5	3.3
65						7.3	5.3	3.1
70						6.6	5.0	2.8
80							4.3	2.3
85							3.6	2.1

Main boom 59 m

Radius (m)	Jib length in (m)							
	20	29	35	47	59	71	83	95
9.4	64.5	t	t	t	t	t	t	t
12	54.8	48.9						
13	51.5	47.3	40.1					
15	46.4	43.7	37.9	26.6				
18	40.2	38.5	34.7	25.2	17.7			
20	36.9	35.5	32.2	23.8	17.1	12.2		
24	31.1	29.9	28.0	21.8	15.8	11.5	8.2	
26		27.4	26.0	20.9	15.3	11.1	7.9	5.4
30		23.8	22.8	19.3	14.6	10.6	7.4	5.1
32		22.4	21.3	18.5	14.3	10.4	7.2	4.9
38			18.1	16.2	13.4	9.8	6.7	4.5
50				12.2	10.8	8.7	5.9	3.8
60					8.8	7.5	5.4	3.3
70						6.3	4.9	2.8
80							4.2	2.2
85							3.3	2.0

Main boom 68 m

Radius (m)	Jib length in (m)							
	20	29	35	47	59	71	83	95
9.7	56.6	t	t	t	t	t	t	t
12	50.3	43.9						
13	47.5	43.1	36.7					
16	40.4	38.9	34.4	24.8				
18	36.9	35.4	32.7	23.8	16.6			
22	31.5	29.8	28.6	21.8	15.7	11.5		
24	29.1	27.6	26.4	20.9	15.1	11.0	7.8	
28		23.6	22.8	19.6	14.4	10.5	7.4	5.1
32		20.9	20.0	17.6	13.8	10.0	7.0	4.8
38			17.1	15.3	12.7	9.4	6.6	4.4
50				11.6	10.1	8.5	5.8	3.7
60					8.2	7.0	5.3	3.2
65						6.4	4.9	3.0
70						5.8	4.6	2.7
80							3.8	2.2
85							3.4	

Main boom 74 m

Radius (m)	Jib length in (m)				
	20	29	35	47	53
9.9	51.7	t	t	t	t
12	47.6	40.4			
13	45.0	40.1	34.3		
16	38.2	36.6	32.7	23.5	
17	36.4	34.9	31.7	23.3	19.1
18	34.8	33.3	31.0	22.8	19.0
19	33.5	32.0	30.1	22.4	18.6
20	32.1	30.8	28.9	21.8	18.2
22	29.8	28.1	27.2	20.9	17.6
24	27.8	26.1	25.1	20.1	17.0
28		22.5	21.6	18.9	16.2
32		20.1	19.0	16.9	15.5
38			16.4	14.6	13.3
46				12.1	11.0
50				11.1	10.2
55					9.2

Capacities in metric tons with luffing jib (No. 1916.xx) 124 t counterweight + 57 t carbody counterweight. Above lift chart is for reference only. For actual lift duty and complete chart with all available configurations please refer to lift chart in operator's cab or manual.

Lift chart – luffing jib (No. 1916.xx)

Main boom angle 83°

Main boom 29 m

Radius (m)	Jib length in (m)							
	20	29	35	47	59	71	83	95
12.6	t	t	t	t	t	t	t	t
16	76.5							
17	65.5	53.3						
17	61.4	50.8	42.1					
22	47.0	41.3	35.3	26.0				
24	41.3	38.6	33.1	24.6	17.5			
26	15.1	36.1	31.1	23.5	17.2			
28		33.8	29.6	22.6	16.7	12.1		
32		28.7	26.3	21.0	15.9	11.6	8.1	
34		25.4	24.9	20.4	15.6	11.3	7.9	
36			23.5	19.8	15.3	11.0	7.6	5.2
40			20.0	18.0	14.7	10.6	7.2	4.9
44				16.6	14.2	10.1	6.9	4.6
50				13.7	13.3	9.5	6.5	4.2
60					10.7	8.7	5.9	3.6
75						6.2	5.2	2.7
85							4.6	2.2

Main boom 41 m

Radius (m)	Jib length in (m)							
	20	29	35	47	59	71	83	95
14	t	t	t	t	t	t	t	t
14	71.6							
17	60.0	50.4						
19	53.8	47.1	39.2					
22	46.9	42.2	35.4	25.4				
26	39.3	37.0	31.4	23.6	16.8			
30		32.5	28.6	22.0	16.1	11.7		
34		27.8	25.5	20.5	15.4	11.2	7.8	
36		15.1	24.3	19.9	15.1	10.9	7.6	5.0
40			21.4	18.5	14.5	10.5	7.2	4.8
50				14.6	13.3	9.5	6.4	4.2
65					9.2	8.4	5.6	3.4
70						7.8	5.4	3.1
75						7.1	5.2	2.8
80							5.0	2.5
85							4.7	2.3
90								2.1

Main boom 53 m

Radius (m)	Jib length in (m)							
	20	29	35	47	59	71	83	95
15.5	t	t	t	t	t	t	t	t
15.5	61.8							
19	50.4	45.6						
20	47.6	44.3	36.4					
24	40.0	38.4	33.0	23.9				
28	35.3	34.1	29.9	22.5	16.1			
32		30.2	27.4	21.1	15.4	11.2		
34		28.4	25.9	20.4	15.1	10.9	7.5	
36		26.3	24.6	19.8	14.8	10.7	7.5	
38			23.5	19.2	14.6	10.5	7.3	4.8
42			20.8	17.9	14.0	10.1	6.9	4.6
50				15.2	13.2	9.4	6.4	4.1
55				11.0	12.7	9.0	6.1	3.9
65					10.1	8.3	5.6	3.4
75						7.3	5.1	2.8
85							4.7	2.3
90								2.1

Main boom 59 m

Radius (m)	Jib length in (m)							
	20	29	35	47	59	71	83	95
16.2	t	t	t	t	t	t	t	t
16.2	57.5							
19	48.8	43.5						
22	41.6	40.4	34.2					
26	36.1	35.1	31.0	22.7				
28	34.2	33.3	29.7	22.1	15.7			
32		29.5	27.2	20.9	15.2	10.9		
36		26.1	24.4	19.6	14.6	10.6	7.4	
38		24.2	23.2	19.0	14.3	10.4	7.2	
40			22.1	18.6	14.1	10.1	7.0	4.7
44			14.9	17.1	13.6	9.8	6.7	4.4
48				15.9	13.2	9.4	6.4	4.2
55				13.2	12.4	8.9	6.0	3.9
65					10.2	8.2	5.5	3.3
75						7.3	5.1	2.8
80							4.9	2.6
90							3.7	2.1

Main boom 68 m

Radius (m)	Jib length in (m)							
	20	29	35	47	59	71	83	95
17.3	t	t	t	t	t	t	t	t
17.3	50.9							
20	44.4	38.8						
22	39.8	37.6	31.9					
26	34.0	33.3	29.8	21.7				
30	30.6	29.9	27.5	20.8	14.9			
34		26.1	25.2	19.8	14.4	10.4		
36		24.7	23.7	19.1	14.1	10.2	7.1	
38		23.1	22.4	18.5	13.9	10.0	7.0	
40			21.3	18.0	13.7	9.8	6.8	4.5
44			19.1	16.7	13.2	9.5	6.6	4.3
55				13.1	11.7	8.7	5.9	3.8
65					9.9	7.9	5.4	3.3
70						7.6	5.2	3.0
80						5.0	4.8	2.5
85							4.5	2.3
90							4.3	2.1

Main boom 74 m

Radius (m)	Jib length in (m)							
	20	29	35	47	59	71	80	
17.7	t	t	t	t	t	t	t	
17.7	48.7							
22	39.5	36.5						
24	35.8	34.6	30.3					
26	33.5	32.8	29.3	21.2				
30	30.2	29.3	27.1	20.6	14.6			
34		25.6	24.8	19.5	14.2	10.3		
36		24.2	23.3	18.9	14.0	10.1	7.7	
38		22.8	22.0	18.3	13.7	9.9	7.7	
44			18.8	16.5	13.0	9.4	7.2	
50				14.5	12.4	8.9	6.8	
55				13.0	11.5	8.6	6.5	
60					10.8	8.2	6.2	
65					9.7	7.8	6.0	
70						7.5	5.7	
80						4.9	5.3	
85							4.9	

Capacities in metric tons with luffing jib (No. 1916.xx) 124 t counterweight + 57 t carbody counterweight. Above lift chart is for reference only. For actual lift duty and complete chart with all available configurations please refer to lift chart in operator's cab or manual.

Lift chart - luffing jib (No. 1916.xx)

Main boom angle 75°

Main boom 29 m

Radius (m)	Jib length in (m)							
	20	29	35	47	59	71	83	95
19.2	64.5	t	t	t	t	t	t	t
24	51.0	44.5						
26	47.2	41.8	35.3					
30	15.1	37.2	31.9					
32		34.8	30.4	22.9				
36		30.1	27.1	21.4	15.9			
38		27.1	25.7	20.7	15.6			
42			22.8	19.3	15.1	10.9		
44			21.2	18.4	14.8	10.6		
46				17.5	14.6	10.4	7.0	
55				13.9	13.4	9.6	6.4	4.2
60					12.5	9.2	6.1	3.9
75						7.8	5.4	3.0
80							5.2	2.8
90							4.9	2.3
95								2.0

Main boom 41 m

Radius (m)	Jib length in (m)							
	20	29	35	47	59	71	83	95
22.3	57.6	t	t	t	t	t	t	t
28	47.0	41.6						
30	44.5	39.5	33.2					
32	41.1	37.6	31.8					
34		35.6	30.3	22.5				
40		29.0	26.1	20.7	15.3			
44			23.6	19.7	14.8	10.5		
46			22.2	18.8	14.6	10.4		
50				17.3	14.2	10.1	6.8	
55				15.5	13.6	9.6	6.5	4.2
60					13.2	9.3	6.2	3.9
70					10.5	8.6	5.7	3.4
80						7.7	5.3	2.9
85							5.2	2.6
90							5.0	2.4
95								2.2

Main boom 53 m

Radius (m)	Jib length in (m)							
	20	29	35	47	59	71	83	95
25.4	46.3	t	t	t	t	t	t	t
30	39.9	38.2						
32	37.5	36.0	32.1					
36	15.1	32.1	29.6					
38		30.4	28.3	21.6				
42		27.8	25.8	20.5	14.7			
44		26.4	24.6	19.9	14.7			
48			22.6	18.9	14.2	10.1		
50			21.5	18.2	14.0	10.0		
55				16.7	13.6	9.6	6.5	
60				14.7	13.2	9.2	6.2	4.0
70					11.4	8.6	5.7	3.5
75						8.4	5.5	3.2
85						6.7	5.2	2.7
95							5.0	2.3
100								2.1

Main boom 59 m

Radius (m)	Jib length in (m)							
	20	29	35	47	59	71	83	95
28	40.6	t	t	t	t	t	t	t
32	35.6	34.0						
34	33.7	32.1	30.0					
36	32.2	30.3	29.0					
40		27.5	26.3	21.0				
44		25.3	24.0	20.0	14.4			
46		24.2	23.0	19.4	14.3			
50			21.3	18.5	13.9	9.8		
55				16.7	13.5	9.5	6.4	
60				15.1	13.1	9.2	6.1	3.9
75					9.5	8.4	5.5	3.2
80						8.1	5.3	3.0
85						7.7	5.1	2.8
90							5.1	2.5
95							5.0	2.3
100								2.1

Main boom 68 m

Radius (m)	Jib length in (m)							
	20	29	35	47	59	71	83	95
29.3	34.7	t	t	t	t	t	t	t
34	30.6	29.1						
36	29.0	27.6	26.2					
40	15.1	25.0	24.1					
42		23.8	23.0	19.9				
46		22.0	21.1	18.9	13.7			
48		21.2	20.2	18.2	13.7			
50			19.5	17.5	13.5			
55				16.0	13.1	9.2		
60				14.7	12.6	9.0	6.0	
65				13.5	11.9	8.7	5.8	3.6
70					11.3	8.4	5.6	3.4
75						10.4	8.2	5.4
85							7.7	5.1
90								5.0
100								4.8

Main boom 74 m

Radius (m)	Jib length in (m)				
	20	29	35	47	53
32	30.5	t	t	t	t
34	28.7				
36	27.2	25.6			
38	25.9	24.4	23.0		
40	24.9	23.2	22.2		
42		22.3	21.3		
44		21.3	20.5	17.8	
46		20.5	19.7	17.2	15.3
48		19.8	18.9	16.7	15.0
50		19.0	18.2	16.1	14.6
55			16.7	14.8	13.5
60				13.7	12.5
65				12.7	11.6
70					10.9
0					
0					

Capacities in metric tons with luffing jib (No. 1916.xx) 124 t counterweight + 57 t carbody counterweight. Above lift chart is for reference only. For actual lift duty and complete chart with all available configurations please refer to lift chart in operator's cab or manual.

Lift chart – luffing jib (No. 1916.xx)

Main boom angle 65°

Main boom 29 m

Radius (m)	Jib length in (m)							
	20	29	35	47	59	71	83	95
28	48.3	t	t	t	t	t	t	t
32	41.1	30.1						
34	38.2	37.9						
36		35.4	31.2					
42		29.4	26.8					
44			25.5	20.2				
48			22.8	19.1				
50				18.1	14.3			
60				14.2	13.2	9.4		
65					12.5	9.1	6.0	
70					11.2	8.8	5.7	3.5
80						8.0	5.3	3.0
85							5.2	2.7
90							5.1	2.5
95							5.0	2.3
100								2.1

Main boom 41 m

Radius (m)	Jib length in (m)							
	20	29	35	47	59	71	83	95
34	35.8	t	t	t	t	t	t	t
38	31.3	30.9						
42		27.4	27.0					
44		25.9	25.5					
48		23.2	23.0	20.0				
50			21.8	19.6				
55				18.1	13.9			
60				16.4	13.6			
65				14.5	13.1	9.1		
70					12.6	8.9	5.8	
75					11.3	8.6	5.6	3.3
80						8.4	5.4	3.2
85						8.0	5.3	2.9
90							5.2	2.7
100							5.1	2.3
105								2.1

Main boom 53 m

Radius (m)	Jib length in (m)							
	20	29	35	47	59	71	83	95
37	29.2	t	t	t	t	t	t	t
44	24.0	23.6						
46		22.3	21.9					
50		20.1	19.8					
55			17.6	16.9				
60				15.1	13.2			
70				12.3	11.6	8.8		
75					10.4	8.6	5.6	
80					9.3	8.4	5.4	3.2
85						7.5	5.3	3.0
90						6.7	5.2	2.8
100							4.5	2.4
105							3.9	2.3
110								2.1

Main boom 59 m

Radius (m)	Jib length in (m)							
	20	29	35	47	59	71	83	95
39.6	25.3	t	t	t	t	t	t	t
46	21.6	21.1						
50		19.0	18.6					
55		16.8	16.5	15.2				
60			14.8	14.1				
65				12.7	11.9			
70				11.4	10.5	8.6		
75					9.4	8.5		
80					8.4	7.5	5.4	
85					7.4	6.7	5.3	3.1
90						5.9	5.0	2.8
95						5.1	4.4	2.7
100							3.7	2.5
105							3.1	2.3

Main boom 68 m

Radius (m)	Jib length in (m)							
	20	29	35	47	59	71	83	95
43.4	20.5	t	t	t	t	t	t	t
50	17.7	17.0						
55		15.2	14.6					
60		13.6	13.2	12.1				
65			11.7	10.9				
70				9.7	8.8			
75				8.6	7.8	6.9		
80					6.8	6.0	5.1	
85					6.0	5.2	4.3	
90						4.5	3.6	2.7
95						3.8	3.0	2.2
100						3.2	2.5	

Main boom 74 m

Radius (m)	Jib length in (m)							
	20	29	35	47	53			
45.9	17.7	t	t	t	t			
48	16.9							
50	16.2							
55		13.6	13.0					
60		12.3	11.8					
65			10.5	9.6	9.1			
70				8.5	8.0			
75				7.4	7.1			
80					6.2			
85					5.4			
0								
0								

Capacities in metric tons with luffing jib (No. 1916.xx) 124 t counterweight + 57 t carbody counterweight. Above lift chart is for reference only. For actual lift duty and complete chart with all available configurations please refer to lift chart in operator's cab or manual.

Lift chart - luffing jib (No. 1916.xx)

Main boom angle 45°

Main boom 29 m

Radius (m)	Jib length in (m)							
	20	29	35	47	59	71	83	95
39.8	28.7	t	t	t	t	t	t	t
42	26.9							
48		22.5						
50		21.4						
55			18.7					
65				14.6				
75					11.4			
80					10.4			
85						8.2		
90						7.8		
95							4.9	
100							4.9	
105								2.1

Main boom 41 m

Radius (m)	Jib length in (m)							
	20	29	35	47	59	71	83	
48.3	19.9	t	t	t	t	t	t	
50	19.0							
60		14.7						
65			12.9					
75				9.9				
85					7.2			
95						4.9		
100						4.2	3.4	
105							2.9	
110							2.4	
0								
0								
0								

Main boom 53 m

Radius (m)	Jib length in (m)					
	20	29	35	47	62	
56.8	13.3	t	t	t	t	
60	12.4					
65		10.5				
70			8.9			
80				6.2		
85				5.4		
95					3.2	
100					2.7	

Main boom 59 m

Radius (m)	Jib length in (m)					
	20	29	35	47		
61	10.4	t	t	t		
70		7.7				
75			6.3			
85				4.0		
90				3.3		
0						
0						
0						

Main boom 68 m

Radius (m)	Jib length in (m)			
	20	29	35	
67.4	6.2	t	t	
70	5.7			
75		4.3		
80			3.1	
85			2.5	

Main boom 74 m

Radius (m)	Jib length in (m)					
	20					
71.6	3.6					

Capacities in metric tons with luffing jib (No. 1916.xx) 124 t counterweight + 57 t carbody counterweight. Above lift chart is for reference only. For actual lift duty and complete chart with all available configurations please refer to lift chart in operator's cab or manual.

Working range - fixed jib (No. 1713.xx) 15° and 30°

Main boom 88° - 30°

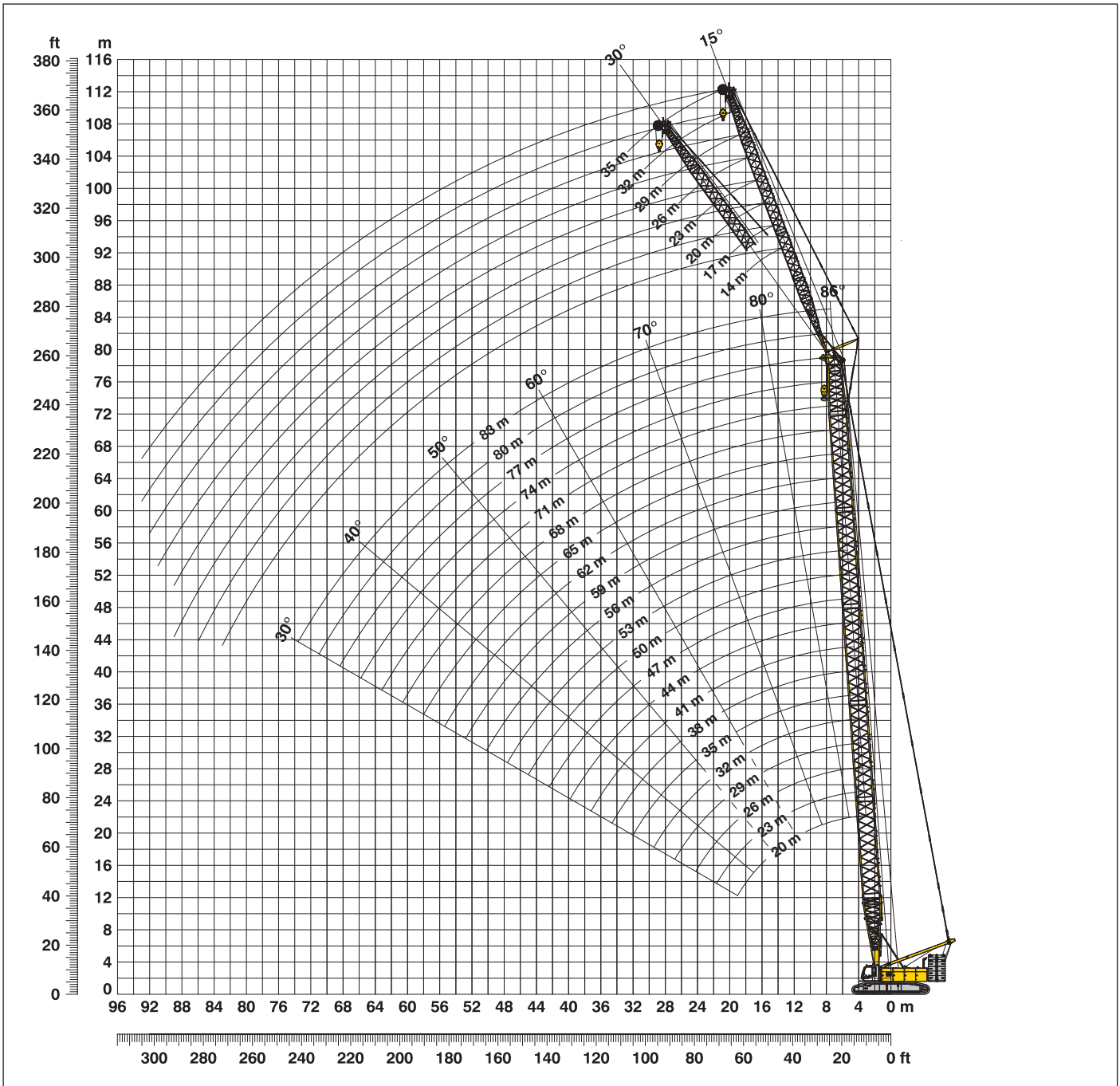

Boom configuration for boom lengths (20 m - 83 m) – see table 1 on page 10

Fixed jib configuration for fixed jib lengths (11 m - 35 m)

	Length	Amount of fixed jib extensions							
Fixed jib foot	7.0 m	1	1	1	1	1	1	1	1
Fixed jib insert	3.0 m		1		1		1		1
Fixed jib insert	6.0 m			1	1			1	1
Fixed jib insert	12.0 m					1	1	1	1
Fixed jib head	7.0 m	1	1	1	1	1	1	1	1
Fixed jib length (m)		14	17	20	23	26	29	32	35

Lift chart - fixed jib (No. 1713.xx)

Offset 15°

Main boom 20 m

Radius	Fixed jib length in (m)			
	14	23	29	35
(m)	t	t	t	t
13	42.9			
15	38.3	26.4		
16	36.6	25.2	21.2	18.4
18	33.9	23.2	19.3	16.7
20	31.3	21.3	17.8	15.5
24	27.6	18.6	15.5	13.4
28	24.0	16.5	13.7	11.8
32	21.7	14.7	12.2	10.6
36		13.3	11.0	9.4
42		11.7	9.6	8.1
48			8.6	7.1
50				6.9

Main boom 29 m

Radius	Fixed jib length in (m)			
	14	23	29	35
(m)	t	t	t	t
12	53.1			
13	49.9	32.9		
14	47.4	31.1	25.6	
16	43.0	28.8	23.2	19.5
20	36.7	24.3	19.8	16.7
24	31.3	21.1	17.3	14.5
32	25.1	16.8	13.7	11.4
36	23.0	15.3	12.4	10.3
40	21.3	14.0	11.4	9.4
50		11.9	9.4	7.6
55			8.7	7.0
60				6.5

Main boom 38 m

Radius	Fixed jib length in (m)			
	14	23	29	35
(m)	t	t	t	t
10	58.6			
12	55.6	34.5		
14	50.4	31.4	25.4	
16	46.2	29.6	23.4	19.7
20	39.7	25.2	20.4	17.1
28	31.0	20.0	16.0	13.5
36	25.9	16.5	13.2	11.1
44	22.4	14.1	11.3	9.3
48	21.1	13.3	10.5	8.7
55		12.1	9.5	7.7
60			8.9	7.2
70				5.7

Main boom 47 m

Radius	Fixed jib length in (m)			
	14	23	29	35
(m)	t	t	t	t
9	60.0			
12	56.1	35.4		
14	52.9	32.7	26.0	
16	48.6	30.2	24.1	19.8
20	42.9	26.6	21.3	17.3
28	34.1	21.5	17.2	14.0
36	28.5	18.0	14.4	11.6
44	24.3	15.6	12.3	9.9
55	16.7	13.3	10.3	8.3
65		12.0	9.2	7.2
70			8.7	6.8
75				6.5

Main boom 56 m

Radius	Fixed jib length in (m)			
	14	23	29	35
(m)	t	t	t	t
8.5	60.0			
12	57.1	34.9		
14	54.2	32.5	25.6	
17	48.8	29.4	23.3	19.1
20	44.6	27.0	21.3	17.6
28	36.1	22.2	17.6	14.4
36	30.5	19.0	14.9	12.2
44	23.5	16.4	12.9	10.6
65	11.4	12.1	9.7	7.7
70		10.3	9.2	7.3
75			8.8	7.0
85				6.4

Main boom 62 m

Radius	Fixed jib length in (m)			
	14	23	29	35
(m)	t	t	t	t
8.7	60.0			
12	57.1	34.8		
15	53.2	31.5	24.7	
17	49.9	29.6	23.4	19.1
28	37.4	22.9	17.9	14.6
36	31.2	19.6	15.3	12.5
44	23.0	17.0	13.4	10.9
55	15.4	14.7	11.4	9.1
70	9.0	9.7	9.6	7.6
75		8.0	8.5	7.2
85			5.4	5.8
90				4.4

Main boom 68 m

Radius	Fixed jib length in (m)			
	14	23	29	35
(m)	t	t	t	t
8.9	57.9			
13	53.3	33.4		
15	51.3	31.7	24.7	
17	49.3	29.9	23.4	19.1
28	39.0	23.5	18.2	14.8
36	31.1	20.1	15.7	12.8
44	22.4	17.7	13.8	11.2
55	14.9	15.1	11.8	9.5
75	6.6	7.4	7.9	7.5
80		5.7	6.3	6.6
90			3.4	3.8
95				2.6

Main boom 77 m

Radius	Fixed jib length in (m)			
	14	23	29	35
(m)	t	t	t	t
9.2	51.4			
13	48.3	33.7		
15	46.5	31.8	24.7	
17	45.2	30.3	23.5	18.9
28	36.8	24.1	18.7	15.0
36	29.3	20.9	16.3	13.1
44	21.7	18.5	14.4	11.4
55	14.1	14.9	12.4	9.8
75	5.6	6.4	6.9	7.2
80	4.0	4.7	5.3	5.6
85		3.3	3.8	4.2
90			2.5	2.9

Main boom 83 m

Radius	Fixed jib length in (m)			
	14	17	20	23
(m)	t	t	t	t
9.4	48.1			
11	47.0	43.0		
12	46.4	42.3	38.8	
13	45.7	41.8	37.7	32.6
16	43.4	39.8	35.1	30.4
20	41.0	37.6	32.1	27.6
28	36.1	32.7	27.5	23.7
36	28.2	26.9	24.1	20.7
44	20.7	20.9	21.0	18.6
55	13.6	13.8	14.1	14.3
75	4.9	5.1	5.4	5.6
85		2.1	2.4	2.6

Capacities in metric tons with fixed jib (No. 1713.xx) 124 t counterweight + 57 t carbody counterweight. Above lift chart is for reference only. For actual lift duty and complete chart with all available configurations please refer to lift chart in operator's cab or manual.

Lift chart - fixed jib (No. 1713.xx)

Offset 30°

Main boom 20 m

Radius	Fixed jib length in (m)			
	14	23	29	35
(m)	t	t	t	t
15	29.1			
18	26.3	17.7		
20	25.0	16.6	13.7	
24	23.7	14.8	12.1	10.3
28	21.7	13.7	11.1	9.3
32	20.6	13.1	10.3	8.6
34	20.2	12.7	10.0	8.2
42		11.5	8.9	7.3
46			8.5	6.8
48			8.4	6.6
50				6.4
55				6.3

Main boom 29 m

Radius	Fixed jib length in (m)			
	14	23	29	35
(m)	t	t	t	t
14	34.1			
17	30.9	20.6		
20	28.4	18.9	15.4	
24	25.8	17.1	13.9	11.5
28	23.8	15.5	12.6	10.4
32	22.2	14.3	11.5	9.5
36	21.0	13.4	10.7	8.7
40	20.4	12.6	9.9	8.1
42	15.1	12.3	9.7	7.8
50		11.6	8.7	6.9
55			8.5	6.5
60				6.3

Main boom 38 m

Radius	Fixed jib length in (m)			
	14	23	29	35
(m)	t	t	t	t
13	36.0			
17	32.0	20.4		
20	30.0	18.9	15.3	
24	27.3	17.3	13.9	11.6
28	25.4	16.0	12.7	10.6
32	23.7	14.9	11.8	9.7
40	21.4	13.1	10.4	8.4
44	20.7	12.5	9.8	7.9
50	15.1	11.8	9.1	7.3
55		11.5	8.6	6.9
60			8.4	6.5
70				6.3

Main boom 47 m

Radius	Fixed jib length in (m)			
	14	23	29	35
(m)	t	t	t	t
11.4	30.1			
17	33.0	20.9		
22	29.8	18.8	14.8	
24	28.5	18.0	14.2	11.6
28	26.7	16.8	13.2	10.7
32	25.0	15.7	12.4	9.9
40	22.6	14.0	11.0	8.7
44	21.7	13.3	10.4	8.2
55	16.9	12.0	9.2	7.2
65		11.7	8.6	6.5
70			8.5	6.4
75				6.3

Main boom 56 m

Radius	Fixed jib length in (m)			
	14	23	29	35
(m)	t	t	t	t
11.7	30.1			
17	33.5	19.7		
22	30.4	18.6	14.7	
24	29.7	18.1	14.2	11.0
32	26.3	15.9	12.4	10.1
40	23.7	14.4	11.1	9.0
48	20.8	13.1	10.1	8.1
55	16.2	12.4	9.4	7.5
65	11.5	11.6	8.7	6.8
70		10.4	8.5	6.6
80			7.6	6.3
85				6.3

Main boom 62 m

Radius	Fixed jib length in (m)			
	14	23	29	35
(m)	t	t	t	t
11.9	30.1			
18	33.2	20.1		
22	30.9	18.7	14.7	
26	29.2	17.6	13.7	11.2
32	26.8	16.2	12.6	10.2
40	24.3	14.7	11.3	9.1
55	15.7	12.7	9.7	7.7
65	11.0	11.9	8.9	7.0
70	9.1	10.1	8.6	6.7
75		8.2	8.5	6.5
85			5.5	6.1
90				4.6

Main boom 68 m

Radius	Fixed jib length in (m)			
	14	23	29	35
(m)	t	t	t	t
12.2	37.2			
18	33.4	20.1		
22	31.3	18.8	14.7	
26	29.8	17.8	13.8	11.2
32	27.3	16.4	12.7	10.2
40	24.8	14.9	11.5	9.2
48	19.8	13.7	10.6	8.4
65	10.6	11.5	9.1	7.1
75	6.7	7.7	8.4	6.6
80		6.0	6.7	6.4
90			3.6	4.2
95				2.8

Main boom 77 m

Radius	Fixed jib length in (m)			
	14	23	29	35
(m)	t	t	t	t
12.5	36.7			
18	33.3	20.4		
22	31.5	19.2	14.8	
26	29.8	18.2	14.0	11.1
32	27.8	16.8	13.0	10.2
40	25.2	15.4	11.9	9.3
48	19.1	14.3	10.9	8.5
65	9.9	10.8	9.5	7.3
75	5.9	6.9	7.5	6.7
80	4.2	5.1	5.9	6.4
90		2.2	2.9	3.4
95				2.1

Main boom 83 m

Radius	Fixed jib length in (m)			
	14	17	20	23
(m)	t	t	t	t
12.7	36.4			
15	35.0	28.5		
17	33.9	27.7	23.3	
18	33.4	27.3	23.0	19.8
24	30.8	25.2	21.2	18.2
32	27.8	22.9	19.3	16.5
40	25.0	21.0	17.8	15.2
48	18.6	18.3	16.4	14.2
55	14.1	14.4	14.7	13.4
65	9.2	9.6	10.0	10.4
75	5.2	5.5	5.9	6.2
85	2.0	2.3	2.7	3.0

Capacities in metric tons with fixed jib (No. 1713.xx) 124 t counterweight + 57 t carbody counterweight. Above lift chart is for reference only. For actual lift duty and complete chart with all available configurations please refer to lift chart in operator's cab or manual.

Working range - fixed jib (No. 1008.xx) 15° and 30°

Main boom 88° - 30°

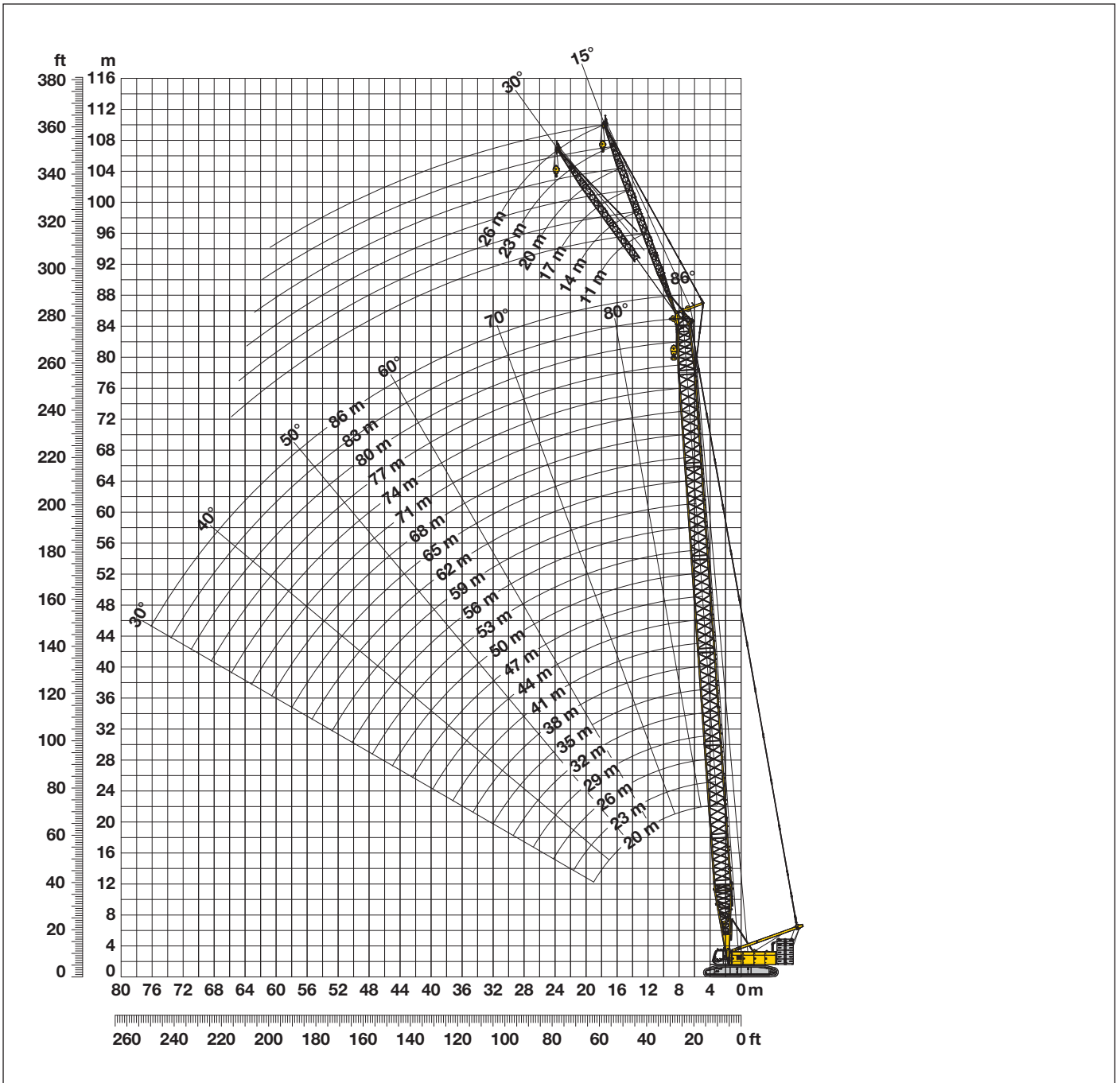

Boom configuration for boom lengths (20 m - 86 m) – see table 1 on page 10

Fixed jib configuration for fixed jib lengths (11 m - 26 m)

	Length	Amount of fixed jib extensions					
Fixed jib foot	5.5 m	1	1	1	1	1	1
Fixed jib insert	3.0 m		1		1		1
Fixed jib insert	6.0 m			1	1	2	2
Fixed jib head	5.5 m	1	1	1	1	1	1
Fixed jib length (m)		11	14	17	20	23	26

Lift chart - fixed jib (No. 1008.xx)

Offset 15°

Main boom 20 m

Radius	Fixed jib length in (m)			
	11	14	20	26
(m)	t	t	t	t
13	44.3			
14	44.0	34.9		
16	40.6	33.1	23.9	
17	38.2	32.1	22.8	16.7
18	36.1	30.4	21.7	16.1
20	32.8	27.5	19.9	15.2
24	27.8	24.1	16.9	13.6
28	24.9	20.6	14.8	11.9
30	23.2	19.4	13.9	11.2
32		18.2	13.2	10.6
38			11.4	9.1
44				8.0

Main boom 29 m

Radius	Fixed jib length in (m)			
	11	14	20	26
(m)	t	t	t	t
11	45.0			
12	45.0	38.3		
14	44.5	37.3	27.0	
16	43.8	35.8	25.2	17.6
20	38.9	32.9	22.0	15.7
28	28.9	25.4	17.0	13.2
32	26.8	22.3	15.3	11.7
36	24.1	20.2	13.9	10.7
38	22.9	19.2	13.4	10.2
40		18.3	13.0	9.8
46			11.5	8.7
50				8.2

Main boom 38 m

Radius	Fixed jib length in (m)			
	11	14	20	26
(m)	t	t	t	t
10	45.0	39.2		
12	45.0	38.1	28.2	
14	45.0	37.0	26.6	18.9
16	43.9	36.2	25.2	17.7
20	40.9	32.7	22.9	16.0
28	33.2	26.5	18.5	13.7
36	27.0	22.0	15.2	11.6
44	23.1	18.9	13.1	10.0
46	22.3	18.2	12.7	9.6
48		17.7	12.3	9.3
55			11.1	8.4
60				7.9

Main boom 47 m

Radius	Fixed jib length in (m)			
	11	14	20	26
(m)	t	t	t	t
9	45.0	40.2		
11	45.0	39.2	29.5	
13	44.4	38.4	28.0	19.3
16	43.2	36.5	26.0	17.8
20	39.3	33.8	23.7	16.3
28	34.3	28.9	19.9	14.1
36	30.5	26.0	16.7	12.5
44	24.4	21.6	14.5	10.8
50	19.9	19.2	13.2	9.8
55		17.3	12.4	9.1
60			11.6	8.6
65				8.1

Main boom 56 m

Radius	Fixed jib length in (m)			
	11	14	20	26
(m)	t	t	t	t
7.1	45.0			
9	45.0	39.6		
11	45.0	38.6	28.6	
13	45.0	37.6	27.3	19.1
20	38.3	32.8	23.4	16.4
28	34.1	28.5	20.2	14.4
36	32.1	25.9	17.6	13.2
44	23.6	22.3	15.3	11.4
55	16.1	16.5	13.1	9.8
60	13.6	14.0	12.4	9.2
70			10.7	8.3
75				7.9

Main boom 62 m

Radius	Fixed jib length in (m)			
	11	14	20	26
(m)	t	t	t	t
7.3	45.0			
9	45.0	39.4		
11	44.5	38.5	28.3	
14	43.3	36.7	26.4	18.5
20	36.9	32.1	23.4	16.3
36	30.0	25.4	18.4	13.3
44	23.1	22.4	15.9	11.9
55	15.5	15.9	13.7	10.2
65	11.0	11.3	12.0	9.0
70		9.5	10.2	8.6
75			8.6	8.3
80				7.5

Main boom 68 m

Radius	Fixed jib length in (m)			
	11	14	20	26
(m)	t	t	t	t
7.5	45.0			
9	45.0	39.2		
11	44.1	38.3	27.8	
14	41.5	35.9	26.2	18.4
20	35.7	31.6	23.4	16.2
36	29.2	25.7	18.9	13.4
44	22.5	22.1	16.5	12.3
55	15.0	15.4	14.1	10.6
70	8.6	9.0	9.7	8.9
75		7.2	7.9	8.5
80			6.3	6.9
85				5.5

Main boom 83 m

Radius	Fixed jib length in (m)			
	11	14	20	26
(m)	t	t	t	t
8	42.5			
10	40.5	36.8		
12	38.7	35.1	26.5	
14	36.8	33.6	25.4	17.7
20	31.6	29.6	22.9	15.8
28	28.4	26.1	20.7	14.3
36	28.4	25.4	19.3	13.4
44	21.0	21.2	17.8	12.7
55	13.6	14.0	14.5	11.2
75	5.1	5.5	6.2	6.9
85	2.1	2.5	3.2	3.8
90				2.5

Main boom 86 m

Radius	Fixed jib length in (m)			
	11	14	17	
(m)	t	t	t	
8.1	42.0			
10	40.1	36.0		
11	39.2	35.1	31.6	
16	34.8	31.4	28.5	
20	30.8	28.8	26.8	
28	26.7	24.9	23.7	
36	26.7	24.5	22.7	
44	20.4	20.8	20.4	
55	13.3	13.7	14.2	
75	4.7	5.0	5.5	
80	3.1	3.5	3.9	
85		2.1	2.5	

Capacities in metric tons with fixed jib (No. 1008.xx) 124 t counterweight + 57 t carbody counterweight. Above lift chart is for reference only. For actual lift duty and complete chart with all available configurations please refer to lift chart in operator's cab or manual.

Lift chart - fixed jib (No. 1008.xx)

Offset 30°

Main boom 20 m

Radius	Fixed jib length in (m)			
	11	14	20	26
(m)	t	t	t	t
15	28.9			
16	28.0	22.9		
19	25.2	20.8	14.6	
22	22.8	18.6	13.3	10.6
24	21.4	17.5	12.5	9.9
26	20.2	16.6	11.8	9.4
28	19.4	15.8	11.2	8.9
30	18.8	15.2	10.7	8.5
32		14.8	10.3	8.0
34		14.5	9.9	7.7
40			9.3	6.9
46				6.5

Main boom 29 m

Radius	Fixed jib length in (m)			
	11	14	20	26
(m)	t	t	t	t
13	33.3			
15	30.9	27.0		
18	28.3	24.2	16.0	
20	27.1	22.4	15.0	11.5
24	24.0	20.0	14.0	10.3
28	21.8	18.0	12.6	9.4
32	20.1	16.6	11.4	8.6
36	19.0	15.6	10.6	8.0
38	18.6	15.3	10.3	7.7
42		15.1	9.8	7.2
48			9.3	6.7
50				6.7

Main boom 38 m

Radius	Fixed jib length in (m)			
	11	14	20	26
(m)	t	t	t	t
12	35.8			
13	34.7	27.7		
16	31.3	26.2	17.0	
19	29.1	23.8	15.7	12.0
20	28.4	23.3	15.3	11.7
24	26.3	20.8	14.5	10.6
32	22.1	17.5	12.0	9.0
40	19.5	15.6	10.5	7.9
46	18.5	14.8	9.8	7.3
48		14.6	9.6	7.1
55			9.3	6.7
60				6.6

Main boom 47 m

Radius	Fixed jib length in (m)			
	11	14	20	26
(m)	t	t	t	t
11	37.9			
12	36.6	29.8		
15	33.5	28.5	17.9	
19	30.1	25.5	16.2	12.1
24	27.6	22.6	14.6	10.8
32	23.7	19.2	12.7	9.3
40	21.0	17.1	11.3	8.3
48	19.2	15.6	10.3	7.5
50	19.0	15.4	10.1	7.4
55		15.0	9.8	7.0
60			9.6	6.7
65				6.6

Main boom 56 m

Radius	Fixed jib length in (m)			
	11	14	20	26
(m)	t	t	t	t
9.7	39.8			
12	37.4	30.1		
16	33.6	27.4	17.2	
19	31.1	25.5	16.1	12.1
24	28.7	23.0	14.7	10.9
32	25.3	19.8	12.9	9.7
40	22.4	17.5	11.6	8.6
48	20.3	16.1	10.6	7.8
60	13.8	14.1	9.6	7.0
65		12.0	9.5	6.8
70			9.3	6.7
75				6.6

Main boom 62 m

Radius	Fixed jib length in (m)			
	11	14	20	26
(m)	t	t	t	t
9.9	39.6			
12	37.6	29.2		
16	34.1	27.4	17.3	
20	31.0	25.1	15.9	11.9
24	29.5	23.2	14.9	11.0
32	26.3	20.3	13.6	9.8
40	23.2	18.1	12.0	8.8
48	20.3	16.5	10.9	8.0
65	11.1	11.5	9.6	6.9
70		9.6	9.4	6.7
75			8.7	6.6
80				6.6

Main boom 68 m

Radius	Fixed jib length in (m)			
	11	14	20	26
(m)	t	t	t	t
10.2	38.7			
12	37.0	28.8		
16	33.6	26.8	17.3	
20	30.8	24.7	16.1	11.9
32	26.0	20.4	13.9	9.9
40	23.4	18.6	12.3	8.9
48	19.8	17.1	11.2	8.2
65	10.7	11.1	9.8	7.1
70	8.8	9.2	9.5	6.9
75		7.3	8.2	6.7
80			6.5	6.7
85				5.7

Main boom 83 m

Radius	Fixed jib length in (m)			
	11	14	20	26
(m)	t	t	t	t
10.7	32.9			
13	31.5	27.2		
17	29.0	25.0	17.2	
20	27.7	23.7	16.5	11.8
24	26.3	22.3	15.6	11.2
32	25.2	20.6	14.1	10.1
40	23.8	19.8	12.8	9.2
48	18.5	17.0	11.9	8.5
65	9.3	9.8	10.0	7.4
75	5.3	5.8	6.7	6.9
85	2.2	2.6	3.5	4.3
90			2.1	2.9

Main boom 86 m

Radius	Fixed jib length in (m)			
	11	14	17	
(m)	t	t	t	
10.8	32.6			
13	31.0	26.3		
15	29.8	25.3	21.1	
18	28.1	23.8	20.0	
24	25.7	21.6	18.3	
32	24.8	20.0	16.6	
40	24.3	19.3	15.1	
48	18.1	16.8	14.1	
65	8.9	9.4	9.9	
75	4.9	5.4	5.9	
80	3.3	3.7	4.2	
85		2.3	2.7	

Capacities in metric tons with fixed jib (No. 1008.xx) 124 t counterweight + 57 t carbody counterweight. Above lift chart is for reference only. For actual lift duty and complete chart with all available configurations please refer to lift chart in operator's cab or manual.

Notice

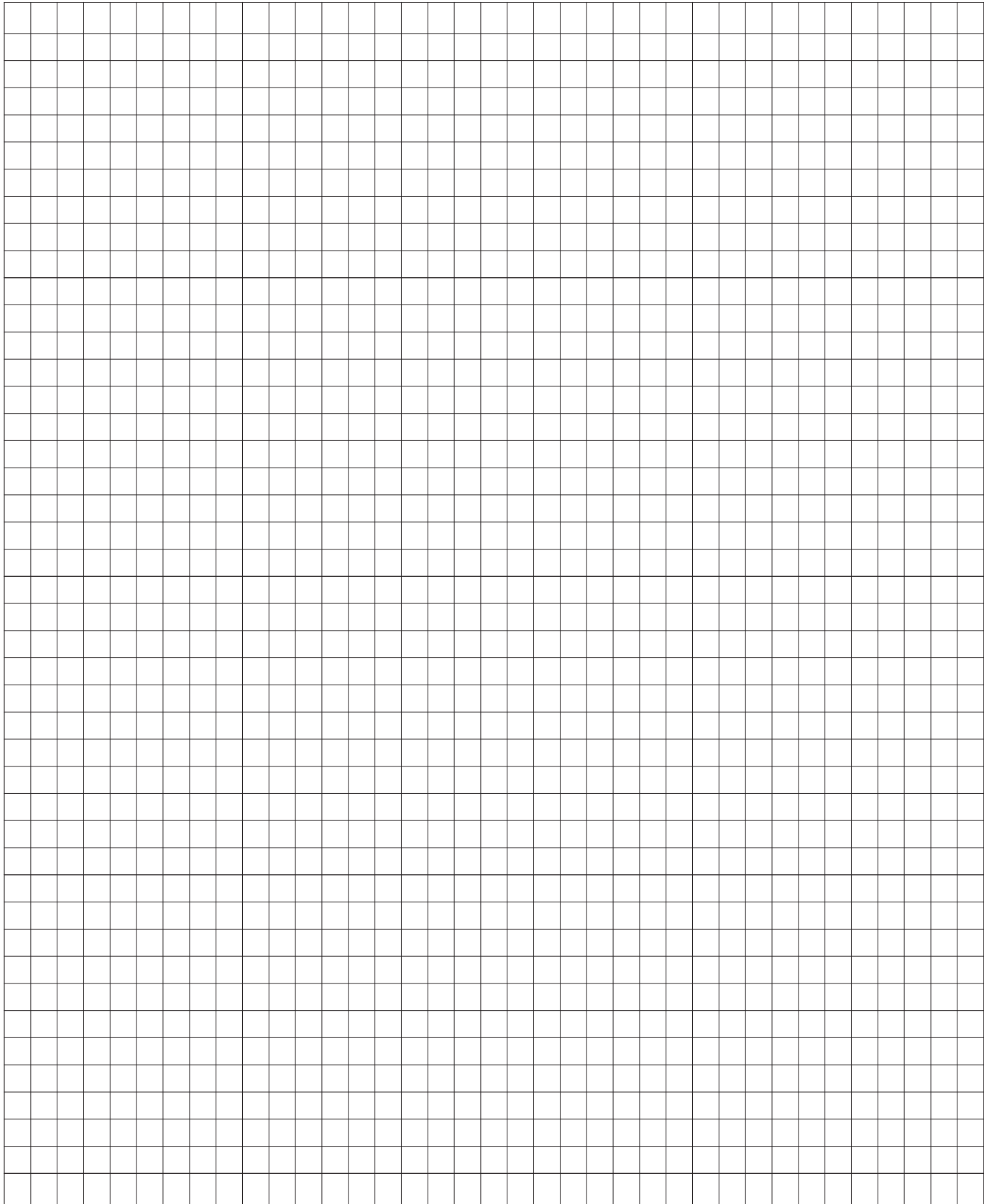

Notice

